

The Computer for the 21st Century

*Specialized elements of hardware and software,
connected by wires, radio waves and infrared, will be
so ubiquitous that no one will notice their presence*

by Mark Weiser

The most profound technologies are those that disappear. They weave themselves into the fabric of everyday life until they are indistinguishable from it.

Consider writing, perhaps the first information technology. The ability to represent spoken language symbolically for long-term storage freed information from the limits of individual memory. Today this technology is ubiquitous in industrialized countries. Not only do books, magazines and newspapers convey written information, but so do street signs, billboards, shop signs and even graffiti. Candy wrappers are covered in writing. The constant background presence of these products of "literacy technology" does not require active attention, but the information to be transmitted is ready for use at a glance. It is difficult to imagine modern life otherwise.

Silicon-based information technology, in contrast, is far from having become part of the environment. More than 50 million personal computers have been sold, and the computer nonetheless remains largely in a world of its own. It

is approachable only through complex jargon that has nothing to do with the tasks for which people use computers. The state of the art is perhaps analogous to the period when scribes had to know as much about making ink or baking clay as they did about writing.

The arcane aura that surrounds personal computers is not just a "user interface" problem. My colleagues and I at the Xerox Palo Alto Research Center think that the idea of a "personal" computer itself is misplaced and that the vision of laptop machines, dynabooks and "knowledge navigators" is only a transitional step toward achieving the real potential of information technology. Such machines cannot truly make computing an integral, invisible part of people's lives. We are therefore trying to conceive a new way of thinking about computers, one that takes into account the human world and allows the computers themselves to vanish into the background.

Such a disappearance is a fundamental consequence not of technology but of human psychology. Whenever people learn something sufficiently well, they cease to be aware of it. When you look at a street sign, for example, you absorb its information without consciously performing the act of reading. Computer scientist, economist and Nobelist Herbert A. Simon calls this phenomenon "compiling"; philosopher Michael Polanyi calls it the "tacit dimension"; psychologist J. J. Gibson calls it "visual invariants"; philosophers Hans Georg Gadamer and Martin Heidegger call it the "horizon" and the "ready-to-hand"; John Seely Brown of PARC calls it the "periphery." All say, in essence, that only when things disappear in this way are we freed to use them without thinking and so to focus beyond them on new goals.

The idea of integrating computers seamlessly into the world at large runs counter to a number of present-day trends. "Ubiquitous computing" in this context does not mean just computers that can be carried to the beach, jungle or airport. Even the most powerful notebook computer, with access to a worldwide information network, still focuses attention on a single box. By analogy with writing, carrying a superlaptop is like owning just one very important book. Customizing this book, even writing millions of other books, does not begin to capture the real power of literacy.

Furthermore, although ubiquitous computers may use sound and video in addition to text and graphics, that does not make them "multimedia computers." Today's multimedia machine makes the computer screen into a demanding focus of attention rather than allowing it to fade into the background.

Perhaps most diametrically opposed to our vision is the notion of virtual reality, which attempts to make a world inside the computer. Users don special goggles that project an artificial scene onto their eyes; they wear gloves or even bodysuits that sense their motions and gestures so that they can move about and manipulate virtual objects. Although it may have its purpose in allowing people to explore realms otherwise inaccessible—the insides of cells, the surfaces of distant planets, the information web of data bases—virtual reality is only a map, not a territory. It excludes desks, offices, other people not wearing goggles and bodysuits, weather, trees, walks, chance encounters and, in general, the infinite richness of the universe. Virtual reality focuses an enormous apparatus on simulating the world rather than on invisibly enhancing the world that already exists.

Indeed, the opposition between the

MARK WEISER is head of the Computer Science Laboratory at the Xerox Palo Alto Research Center. He is working on the next revolution of computing after workstations, variously known as ubiquitous computing or embodied virtuality. Before working at PARC, he was a professor of computer science at the University of Maryland; he received his Ph.D. from the University of Michigan in 1979. Weiser also helped found an electronic publishing company and a video arts company and claims to enjoy computer programming "for the fun of it." His most recent technical work involved the implementation of new theories of automatic computer memory reclamation, known in the field as garbage collection.

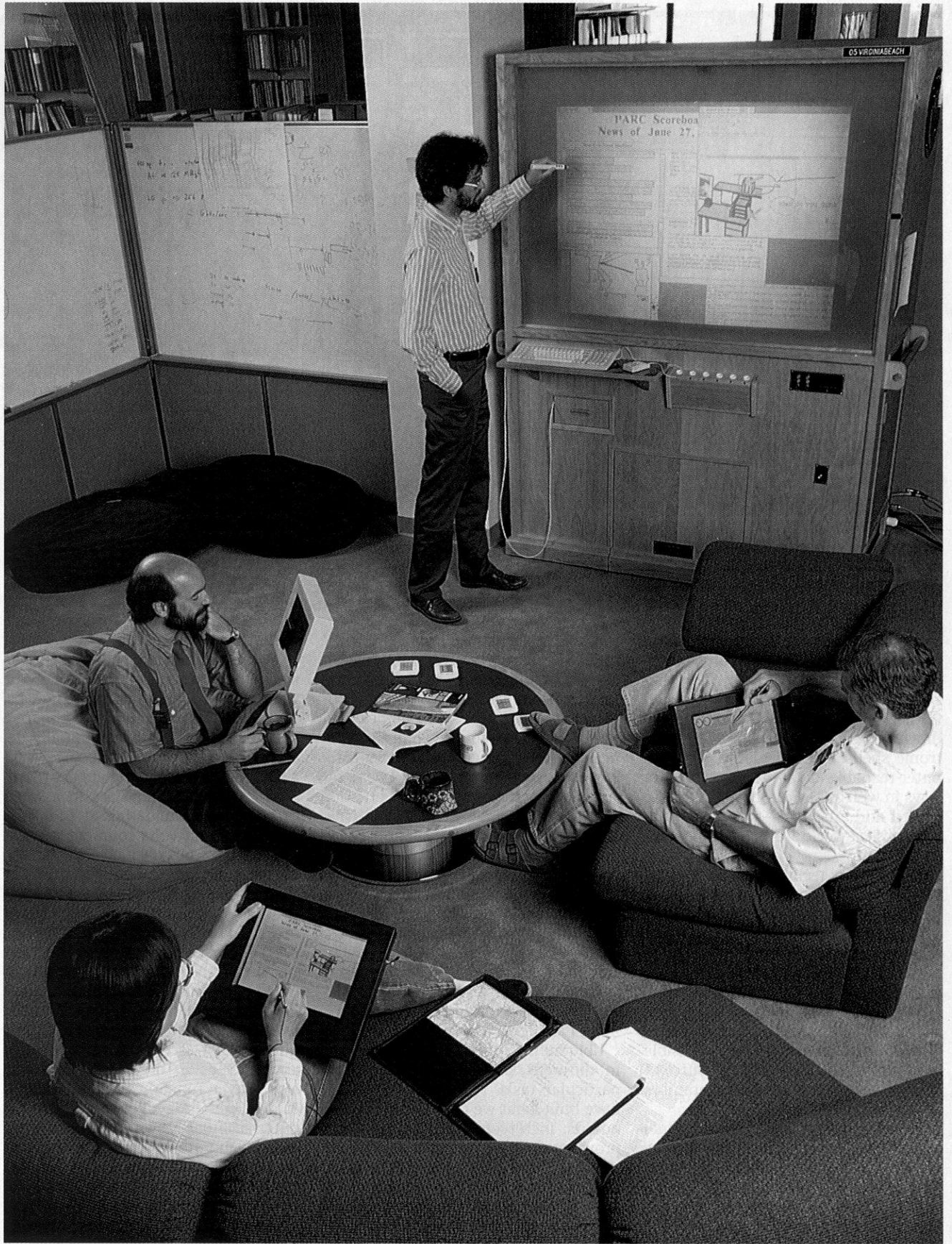

UBIQUITOUS COMPUTING begins to emerge in the form of live boards that replace chalkboards as well as in other devices at the Xerox Palo Alto Research Center. Computer scientists gather around a live board for discussion. Building boards

and integrating them with other tools has helped researchers understand better the eventual shape of ubiquitous computing. In conjunction with active badges, live boards can customize the information they display.

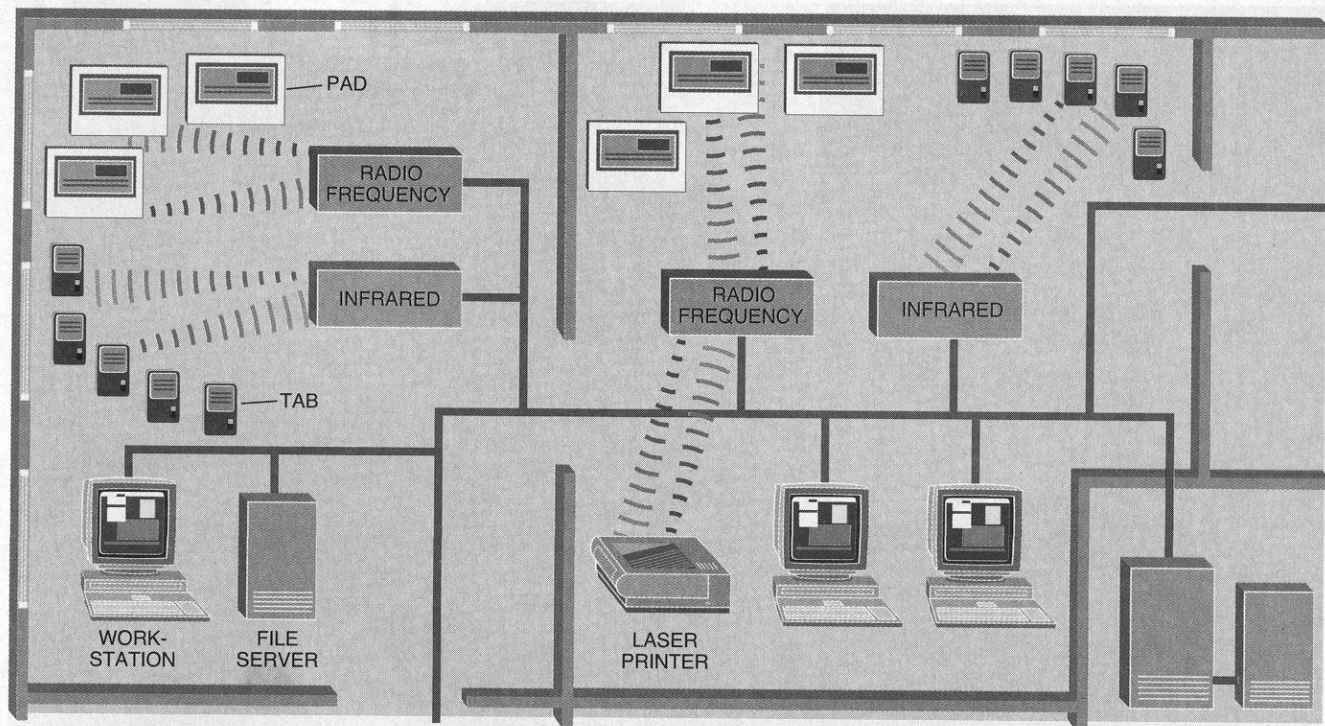

WIRED AND WIRELESS NETWORKS link computers and allow their users to share programs and data. The computers pictured here include conventional terminals and file servers, pocket-size machines known as tabs and page-size ones

known as pads. Future networks must be capable of supporting hundreds of devices in a single room and must also cope with devices—ranging from tabs to laser printers or large-screen displays—that move from one place to another.

notion of virtual reality and ubiquitous, invisible computing is so strong that some of us use the term “embodied virtuality” to refer to the process of drawing computers out of their electronic shells. The “virtuality” of computer-readable data—all the different ways in which they can be altered, processed and analyzed—is brought into the physical world.

How do technologies disappear into the background? The vanishing of electric motors may serve as an instructive example. At the turn of the century, a typical workshop or factory contained a single engine that drove dozens or hundreds of different machines through a system of shafts and pulleys. Cheap, small, efficient electric motors made it possible first to give each tool its own source of motive force, then to put many motors into a single machine.

A glance through the shop manual of a typical automobile, for example, reveals 22 motors and 25 solenoids. They start the engine, clean the windshield, lock and unlock the doors, and so on. By paying careful attention, the driver might be able to discern whenever he or she activated a motor, but there would be no point to it.

Most computers that participate in embodied virtuality will be invisible in

fact as well as in metaphor. Already computers in light switches, thermostats, stereos and ovens help to activate the world. These machines and more will be interconnected in a ubiquitous network. As computer scientists, however, my colleagues and I have focused on devices that transmit and display information more directly. We have found two issues of crucial importance: location and scale. Little is more basic to human perception than physical juxtaposition, and so ubiquitous computers must know where they are. (Today’s computers, in contrast, have no idea of their location and surroundings.) If a computer knows merely what room it is in, it can adapt its behavior in significant ways without requiring even a hint of artificial intelligence.

Ubiquitous computers will also come in different sizes, each suited to a particular task. My colleagues and I have built what we call tabs, pads and boards: inch-scale machines that approximate active Post-it notes, foot-scale ones that behave something like a sheet of paper (or a book or a magazine) and yard-scale displays that are the equivalent of a blackboard or bulletin board.

How many tabs, pads and board-size writing and display surfaces are there in a typical room? Look around you: at the inch scale, include wall notes, titles on book spines, labels on con-

trols, thermostats and clocks, as well as small pieces of paper. Depending on the room, you may see more than 100 tabs, 10 or 20 pads and one or two boards. This leads to our goal for initially deploying the hardware of embodied virtuality: hundreds of computers per room.

Hundreds of computers in a room could seem intimidating at first, just as hundreds of volts coursing through wires in the walls once did. But like the wires in the walls, these hundreds of computers will come to be invisible to common awareness. People will simply use them unconsciously to accomplish everyday tasks.

Tabs are the smallest components of embodied virtuality. Because they are interconnected, tabs will expand on the usefulness of existing inch-scale computers, such as the pocket calculator and the pocket organizer. Tabs will also take on functions that no computer performs today. For example, computer scientists at PARC and other research laboratories around the world have begun working with active badges—clip-on computers roughly the size of an employee I.D. card, first developed by the Olivetti Cambridge research laboratory. These badges can identify themselves to receivers placed throughout a building, thus making it possible to keep track of the people or objects to which they are attached.

In our experimental embodied virtuality, doors open only to the right badge wearer, rooms greet people by name, telephone calls can be automatically forwarded to wherever the recipient may be, receptionists actually know where people are, computer terminals retrieve the preferences of whoever is sitting at them, and appointment diaries write themselves. The automatic diary shows how such a simple task as knowing where people are can yield complex dividends: meetings, for example, consist of several people spending time in the same room, and the subject of a meeting is most probably the files called up on that room's display screen while the people are there. No revolution in artificial intelligence is needed, merely computers embedded in the everyday world.

My colleague Roy Want has designed a tab incorporating a small display that can serve simultaneously as an active badge, calendar and diary. It will also act as an extension to computer screens: instead of shrinking a program window down to a small icon on the screen, for example, a user will be able to shrink the window onto a tab display. This will leave the screen free for information and also let people arrange their computer-based projects in the area around their terminals, much as they now arrange paper-based projects in piles on desks and tables. Carrying a project to a different office for discussion is as simple as gathering up its tabs; the associated programs and files can be called up on any terminal.

The next step up in size is the pad, something of a cross between a sheet of paper and current laptop and palmtop computers. Robert Krivacic of PARC has built a prototype pad that uses two microprocessors, a workstation-size display, a multibutton stylus and a radio network with enough communications bandwidth to support hundreds of devices per person per room.

Pads differ from conventional portable computers in one crucial way. Whereas portable computers go everywhere with their owners, the pad that must be carried from place to place is a failure. Pads are intended to be "scrap computers" (analogous to scrap paper) that can be grabbed and used anywhere; they have no individualized identity or importance.

One way to think of pads is as an antidote to windows. Windows were invented at PARC and popularized by Apple in the Macintosh as a way of fitting several different activities onto the small space of a computer screen at the same

time. In 20 years computer screens have not grown much larger. Computer window systems are often said to be based on the desktop metaphor—but who would ever use a desk only nine inches high by 11 inches wide?

Pads, in contrast, use a real desk. Spread many electronic pads around on the desk, just as you spread out papers. Have many tasks in front of you, and use the pads as reminders. Go beyond the desk to drawers, shelves, coffee tables. Spread the many parts of the many tasks of the day out in front of you to fit both the task and the reach of your arms and eyes rather than to fit the limitations of glassblowing. Someday pads may even be as small and light as actual paper, but meanwhile they can fulfill many more of paper's functions than can computer screens.

Yard-size displays (boards) serve a

number of purposes: in the home, video screens and bulletin boards; in the office, bulletin boards, white boards or flip charts. A board might also serve as an electronic bookcase from which one might download texts to a pad or tab. For the time being, however, the ability to pull out a book and place it comfortably on one's lap remains one of the many attractions of paper. Similar objections apply to using a board as a desktop; people will have to become accustomed to having pads and tabs on a desk as an adjunct to computer screens before taking embodied virtuality any further.

Prototype boards, built by Richard Bruce and Scott Elrod of PARC, are in use at several Xerox research laboratories. They measure about 40 by 60 inches and display 1,024 x 768 black-and-white pixels. To manipulate the

The Active Badge

This harbinger of inch-scale computers contains a small microprocessor and an infrared transmitter. The badge broadcasts the identity of its wearer and so can trigger automatic doors, automatic telephone forwarding and computer displays customized to each person reading them. The active badge and other networked tiny computers are called tabs.

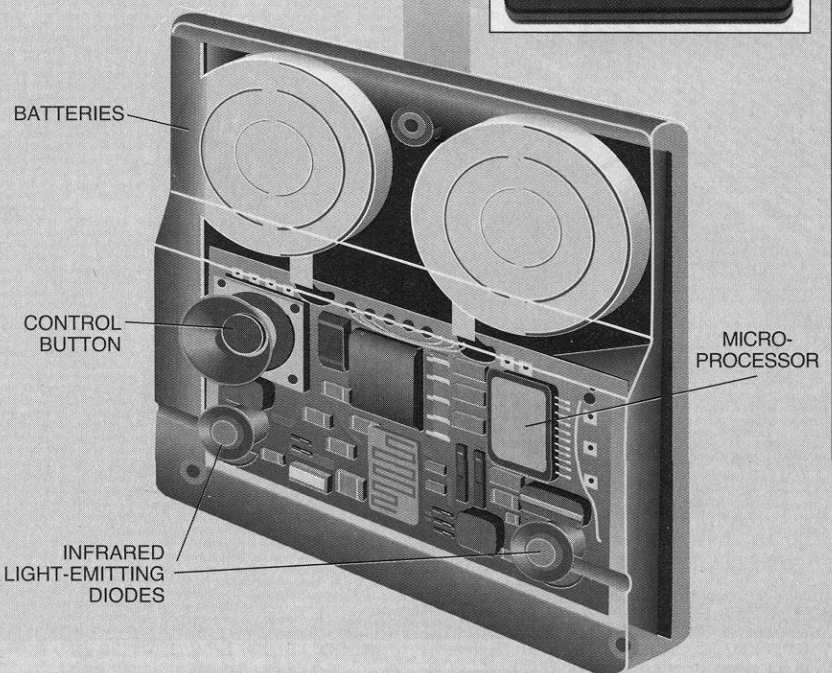

display, users pick up a piece of wireless electronic "chalk" that can work either in contact with the surface or from a distance. Some researchers, using themselves and their colleagues as guinea pigs, can hold electronically mediated meetings or engage in other forms of collaboration around a live board. Others use the boards as testbeds for improved display hardware, new "chalk" and interactive software.

For both obvious and subtle reasons, the software that animates a large shared display and its electronic chalk is not the same as that for a workstation. Switching back and forth between chalk and keyboard may involve walking several steps, and so the act is qualitatively different from using a keyboard and mouse. In addition, body size is an issue. Not everyone can reach the top of the board, so a Macintosh-style menu bar might have to run across the bottom of the screen instead.

We have built enough live boards to permit casual use: they have been placed in ordinary conference rooms and open areas, and no one need sign up or give advance notice before using them. By building and using these boards, researchers start to experience

and so understand a world in which computer interaction informally enhances every room. Live boards can usefully be shared across rooms as well as within them. In experiments instigated by Paul Dourish of EuroPARC and Sara Bly and Frank Halasz of PARC, groups at widely separated sites gathered around boards—each displaying the same image—and jointly composed pictures and drawings. They have even shared two boards across the Atlantic.

Live boards can also be used as bulletin boards. There is already too much text for people to read and comprehend all of it, and so Marvin Theimer and David Nichols of PARC have built a prototype system that attunes its public information to the people reading it. Their "scoreboard" requires little or no interaction from the user other than to look and to wear an active badge.

Prototype tabs, pads and boards are just the beginning of ubiquitous computing. The real power of the concept comes not from any one of these devices—it emerges from the interaction of all of them. The hundreds of processors and displays are not a "user interface" like a mouse and windows, just

a pleasant and effective "place" to get things done.

What will be most pleasant and effective is that tabs can animate objects previously inert. They can beep to help locate mislaid papers, books or other items. File drawers can open and show the desired folder—no searching. Tabs in library catalogues can make active maps to any book and guide searchers to it, even if it is off the shelf, left on a table by the last reader.

In presentations, the size of text on overhead slides, the volume of the amplified voice, even the amount of ambient light, can be determined not by guesswork but by the desires of the listeners in the room at that moment. Software tools for tallying votes instantly and consensus checking are already available in electronic meeting rooms of some large corporations; tabs can make them widespread.

The technology required for ubiquitous computing comes in three parts: cheap, low-power computers that include equally convenient displays, software for ubiquitous applications and a network that ties them all together. Current trends suggest that

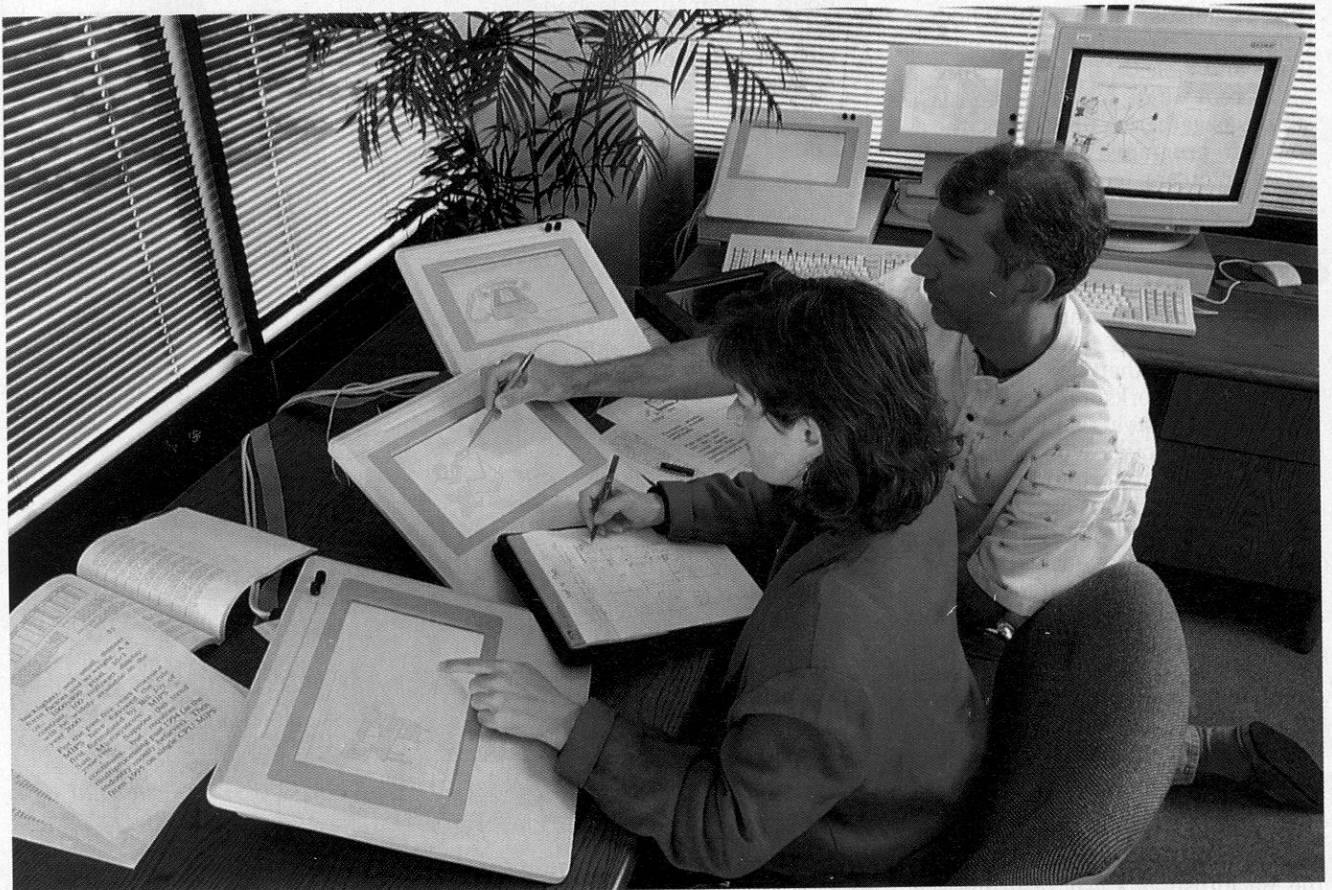

COMPUTER SCRATCHPADS augment the conventional screen in this office at the Xerox Palo Alto Research Center. Proto-

type pads are wired to conventional computers; thus far only a handful of wireless models have been built.

the first of these requirements will easily be met. Flat-panel displays containing 640×480 black-and-white pixels are now common. This is the standard size for PCs and is also about right for television. As long as laptop, palmtop and notebook computers continue to grow in popularity, display prices will fall, and resolution and quality will rise. By the end of the decade, a 1,000×800-pixel high-contrast display will be a fraction of a centimeter thick and weigh perhaps 100 grams. A small battery will provide several days of continuous use.

Larger displays are a somewhat different issue. If an interactive computer screen is to match a white board in usefulness, it must be viewable from arm's length as well as from across a room. For close viewing, the density of picture elements should be no worse than on a standard computer screen, about 80 per inch. Maintaining a density of 80 pixels per inch over an area several feet on a side implies displaying tens of millions of pixels. The biggest computer screen made today has only about one fourth that capacity. Such large displays will probably be expensive, but they should certainly be available.

The large display will require advanced microprocessors to feed it. Central-processing-unit speeds reached a million instructions per second in 1986 and continue to double each year. Some industry observers believe that this exponential growth in raw chip speed may begin to level off about 1994 but that other measures of performance, including power consumption and auxiliary functions, will still improve. The 100-gram flat-panel display, then, might be driven by a microprocessor that executes a billion operations per second and contains 16 megabytes of on-board memory along with sound, video and network interfaces. Such a processor would draw, on average, a few percent of the power required by the display.

Auxiliary storage devices will augment main memory capacity: conservative extrapolation of current technology suggests that removable hard disks (or nonvolatile memory chips) the size of a matchbook will store about 60 megabytes each. Larger disks containing several gigabytes of information will be standard, and terabyte storage—roughly the data content of the Library of Congress—will be common. Such enormous stores will not necessarily be filled to capacity with usable information. Abundant space will, however, allow radically different strategies of information management. A terabyte of disk storage will make deleting old

files virtually unnecessary, for example.

Although processors and displays should be capable of offering ubiquitous computing by the end of the decade, trends in software and network technology are more problematic. Current implementations of “distributed computing” simply make networked file servers, printers or other devices appear as if they were connected directly to each user's computer. This approach, however, does nothing to exploit the unique capabilities of physically dispersed computers and the information embodied in knowing where a particular device is located.

Computer operating systems and window-based display software will have to change substantially. The design of current operating systems, such as DOS and Unix, is based on the assumption that a computer's hardware and software configuration will not change substantially while it is running. This assumption is reasonable for conventional mainframes and personal computers, but it makes no sense in terms of ubiquitous computing. Pads, tabs and even boards may come and go at any time in any room, and it will certainly be impossible to shut down all the computers in a room to install new software in any one of them. (Indeed, it may be impossible to find all the computers in a room.)

One solution may be “micro-kernel” operating systems such as those developed by Rick Rashid of Carnegie Mellon University and A. S. Tanenbaum of Vrije University in Amsterdam. These experimental systems contain only the barest scaffolding of fixed computer code; software modules to perform specific functions can be readily added or removed. Future operating systems based on this principle could shrink and grow automatically to fit the changing needs of ubiquitous computation.

Current window display systems also are not ready to cope with ubiquitous computing. They typically assume that a particular computer will display all the information for a single application. Although the X Window System and Windows 3.0, for example, can cope with multiple screens, they do not do well with applications that start out on one screen and move to another, much less those that peregrinate from computer to computer or room to room.

Solutions to this problem are in their infancy. Certainly no existing display system can perform well while working with the full diversity of input and output forms required by embodied virtual-

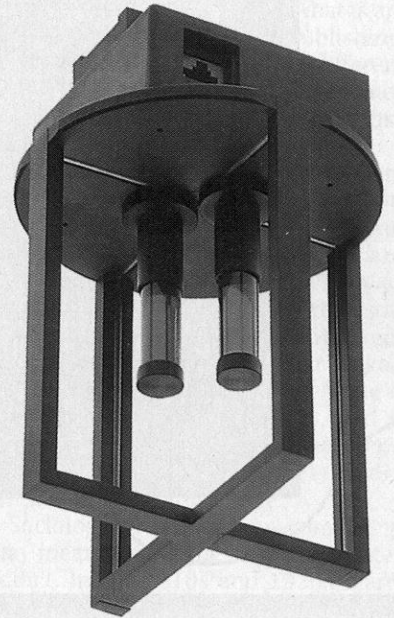

RADIO TRANSCEIVER links pads and other movable computer devices to the wired network. This unit, intended to be mounted on the ceiling, contains antennas in its crossed arms and two light-emitting diodes to signal its status.

ity. Making pads, tabs and boards work together seamlessly will require changes in the kinds of protocols by which applications programs and their displayed windows communicate.

The network that will connect ubiquitous hardware and software poses further challenges. Data transmission rates for both wired and wireless networks are increasing rapidly. Access to gigabit-per-second wired nets is already possible, although expensive, and will become progressively cheaper. (Gigabit networks will seldom devote all of their bandwidth to a single data stream; instead they will allow enormous numbers of lower-speed transmissions to proceed simultaneously.) Small wireless networks, based on digital cellular telephone principles, currently offer data rates between two and 10 megabits per second over a range of a few hundred meters. Low-power wireless networks capable of transmitting 250,000 bits per second to each station will eventually be available commercially.

Yet the problem of transparently linking wired and wireless networks resists solution. Although some stop-gap methods have been developed, engineers must develop new communications protocols that explicitly recognize the concept of machines that move in physical space. Furthermore, the number of channels envisioned in most wireless network schemes is still

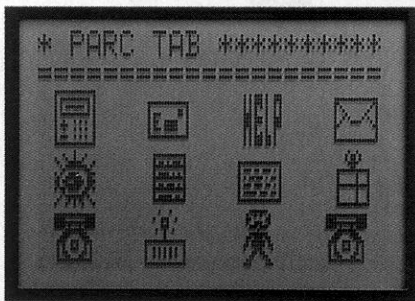
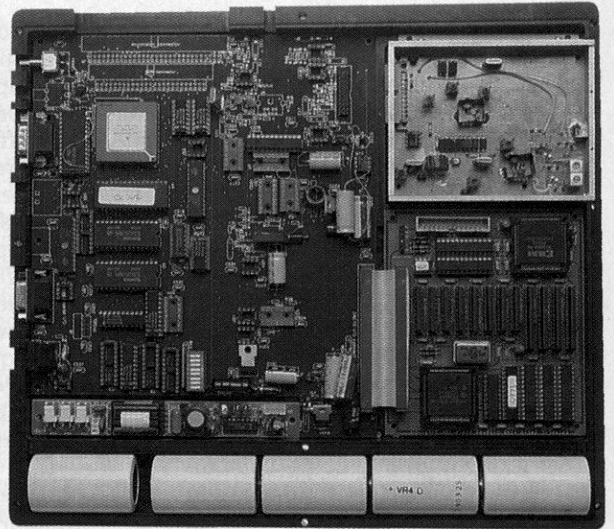
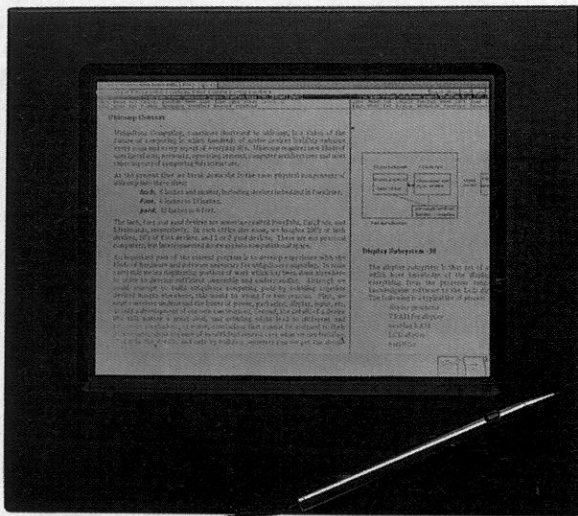

KEY COMPONENTS OF UBIQUITOUS COMPUTING are the pads and tabs under development at the Xerox Palo Alto Research Center. The page-size pad (*top, exterior and interior views*) contains two microprocessors, four million bytes of random-access memory, a high-speed radio link, a high-resolution pen interface and a black-and-white display that is 1,024 by 768 pixels. Because it uses standard window system software, the pad can communicate with most workstations. The much smaller tab (*at left*), 2 3/4 by 3 1/4 inches, has three control buttons, a pen interface, audio and an infrared link for communicating throughout a room. The author believes future homes and offices will contain hundreds of these tiny computers.

very small, and the range large (50 to 100 meters), so that the total number of mobile devices is severely limited. The ability of such a system to support hundreds of machines in every room is out of the question. Single-room networks based on infrared or newer electromagnetic technologies have enough channel capacity for ubiquitous computers, but they can work only indoors.

Present technologies would require a mobile device to have three different network connections: tiny-range wireless, long-range wireless and very high speed wired. A single kind of network connection that can somehow serve all three functions has yet to be invented.

Neither an explication of the principles of ubiquitous computing nor a list of the technologies involved really gives a sense of what it would be like to live in a world full of invisible widgets. Extrapolating from today's rudimentary fragments of embodied virtuality is like trying to predict the publication of *Finnegans Wake* shortly after having inscribed the first clay tablets. Nevertheless, the effort is probably worthwhile:

Sal awakens; she smells coffee. A few

minutes ago her alarm clock, alerted by her restless rolling before waking, had quietly asked, "Coffee?" and she had mumbled, "Yes." "Yes" and "no" are the only words it knows.

Sal looks out her windows at her neighborhood. Sunlight and a fence are visible through one, and through others she sees electronic trails that have been kept for her of neighbors coming and going during the early morning. Privacy conventions and practical data rates prevent displaying video footage, but time markers and electronic tracks on the neighborhood map let Sal feel cozy in her street.

Glancing at the windows to her kids' rooms, she can see that they got up 15 and 20 minutes ago and are already in the kitchen. Noticing that she is up, they start making more noise.

At breakfast Sal reads the news. She still prefers the paper form, as do most people. She spots an interesting quote from a columnist in the business section. She wipes her pen over the newspaper's name, date, section and page number and then circles the quote. The pen sends a message to the paper, which transmits the quote to her office.

Electronic mail arrives from the company that made her garage door opener. She had lost the instruction manual and asked them for help. They have sent her a new manual and also something unexpected—a way to find the old one. According to the note, she can press a code into the opener and the

missing manual will find itself. In the garage, she tracks a beeping noise to where the oil-stained manual had fallen behind some boxes. Sure enough, there is the tiny tab the manufacturer had affixed in the cover to try to avoid E-mail requests like her own.

On the way to work Sal glances in the foreview mirror to check the traffic. She spots a slowdown ahead and also notices on a side street the telltale green in the foreview of a food shop, and a new one at that. She decides to take the next exit and get a cup of coffee while avoiding the jam.

Once Sal arrives at work, the foreview helps her find a parking spot quickly. As she walks into the building, the machines in her office prepare to log her in but do not complete the sequence until she actually enters her office. On her way, she stops by the offices of four or five colleagues to exchange greetings and news.

Sal glances out her windows: a gray day in Silicon Valley, 75 percent humidity and 40 percent chance of afternoon showers; meanwhile it has been a quiet morning at the East Coast office. Usually the activity indicator shows at least one spontaneous, urgent meeting by now. She chooses not to shift the window on the home office back three hours—too much chance of being caught by surprise. But she knows others who do, usually people who never get a call from the East but just want to feel involved.

The telltale by the door that Sal pro-

grammed her first day on the job is blinking: fresh coffee. She heads for the coffee machine.

Coming back to her office, Sal picks up a tab and "waves" it to her friend Joe in the design group, with whom she has a joint assignment. They are sharing a virtual office for a few weeks. The sharing can take many forms—in this case, the two have given each other access to their location detectors and to each other's screen contents and location. Sal chooses to keep miniature versions of all Joe's tabs and pads in view and three-dimensionally correct in a little suite of tabs in the back corner of her desk. She can't see what anything says, but she feels more in touch with his work when noticing the displays change out of the corner of her eye, and she can easily enlarge anything if necessary.

A blank tab on Sal's desk beeps and displays the word "Joe" on it. She picks it up and gestures with it toward her live board. Joe wants to discuss a document with her, and now it shows up on the wall as she hears Joe's voice:

"I've been wrestling with this third paragraph all morning, and it still has the wrong tone. Would you mind reading it?"

Sitting back and reading the paragraph, Sal wants to point to a word. She gestures again with the "Joe" tab onto a nearby pad and then uses the stylus to circle the word she wants:

"I think it's this term 'ubiquitous.' It's just not in common enough use and makes the whole passage sound a little formal. Can we rephrase the sentence to get rid of it?"

"I'll try that. Say, by the way, Sal, did you ever hear from Mary Hausdorf?"

"No. Who's that?"

"You remember. She was at the meeting last week. She told me she was going to get in touch with you."

Sal doesn't remember Mary, but she does vaguely remember the meeting. She quickly starts a search for meetings held during the past two weeks with more than six people not previously in meetings with her and finds the one. The attendees' names pop up, and she sees Mary.

As is common in meetings, Mary made some biographical information about herself available to the other attendees, and Sal sees some common background. She'll just send Mary a note and see what's up. Sal is glad Mary did not make the biography available only during the time of the meeting, as many people do....

In addition to showing some of the ways that computers can enter invisibly

into people's lives, this scenario points up some of the social issues that embodied virtuality will engender. Perhaps key among them is privacy: hundreds of computers in every room, all capable of sensing people near them and linked by high-speed networks, have the potential to make totalitarianism up to now seem like sheerest anarchy. Just as a workstation on a local-area network can be programmed to intercept messages meant for others, a single rogue tab in a room could potentially record everything that happened there.

Even today the active badges and self-writing appointment diaries that offer all kinds of convenience could be a source of real harm in the wrong hands. Not only corporate superiors or underlings but also overzealous government officials and even marketing firms could make unpleasant use of the same information that makes invisible computers so convenient.

Fortunately, cryptographic techniques already exist to secure messages from one ubiquitous computer to another and to safeguard private information stored in networked systems. If designed into systems from the outset, these techniques can ensure that private data do not become public. A well-implemented version of ubiquitous computing could even afford better privacy protection than exists today.

By pushing computers into the background, embodied virtuality will make individuals more aware of the people on the other ends of their computer links. This development may reverse the unhealthy centripetal forces that conventional personal computers have introduced into life and the workplace.

Even today, people holed up in windowless offices before glowing computer screens may not see their fellows for the better part of each day. And in virtual reality, the outside world and all its inhabitants effectively cease to exist. Ubiquitous computers, in contrast, reside in the human world and pose no barrier to personal interactions. If anything, the transparent connections that they offer between different locations and times may tend to bring communities closer together.

My colleagues and I at PARC believe that what we call ubiquitous computing will gradually emerge as the dominant mode of computer access over the next 20 years. Like the personal computer, ubiquitous computing will produce nothing fundamentally new, but by making everything faster and easier to do, with less strain and fewer mental

gymnastics, it will transform what is apparently possible. Desktop publishing, for example, is essentially no different from computer typesetting, which dates back to the mid-1960s. But ease of use makes an enormous difference.

When almost every object either contains a computer or can have a tab attached to it, obtaining information will be trivial: "Who made that dress? Are there any more in the store? What was the name of the designer of that suit I liked last week?" The computing environment knows the suit you looked at for a long time last week because it knows both of your locations, and it can retroactively find the designer's name even though that information did not interest you at the time.

Sociologically, ubiquitous computing may mean the decline of the computer addict. In the 1910s and 1920s many people "hacked" on crystal sets to take advantage of the new high-tech world of radio. Now crystal-and-cat's-whisker receivers are rare because high-quality radios are ubiquitous. In addition, embodied virtuality will bring computers to the presidents of industries and countries for nearly the first time. Computer access will penetrate all groups in society.

Most important, ubiquitous computers will help overcome the problem of information overload. There is more information available at our fingertips during a walk in the woods than in any computer system, yet people find a walk among trees relaxing and computers frustrating. Machines that fit the human environment instead of forcing humans to enter theirs will make using a computer as refreshing as taking a walk in the woods.

FURTHER READING

- THE TACIT DIMENSION. Michael Polanyi. Doubleday & Company, 1966.
- TOWARD PORTABLE IDEAS. Mark Stefik and John Seely Brown in *Technological Support for Work Group Collaboration*. Edited by Margrethe H. Olson. Lawrence Erlbaum Associates, 1989.
- RECENT DEVELOPMENTS IN OPERATING SYSTEMS. Special issue of *Computer (IEEE Computer Society)*, Vol. 23, No. 5; May 1990.
- ACTIVITY-BASED INFORMATION RETRIEVAL: TECHNOLOGY IN SUPPORT OF HUMAN MEMORY. Mik Lamming and William Newman. Available as Rank Xerox EuroPARC Technical Report 91-03; February 1991.
- LCDS AND BEYOND. Nick Baran in *Byte*, Vol. 16, No. 2, pages 229-236; February 1991.
- A TALK WITH INTEL. Kenneth M. Sheldon in *Byte*, Vol. 16, No. 4, pages 131-140; April 1991.