

Constraint Satisfaction Problems (CSPs)

This lecture topic (two lectures)
Chapter 6.1 – 6.4, except 6.3.3

Next lecture topic (two lectures)
Chapter 7.1 – 7.5

(Please read lecture topic material before and after
each lecture on that topic)

Outline

- What is a CSP
- Backtracking for CSP
- Local search for CSPs
- ~~(Removed) Problem structure and decomposition~~

You Will Be Expected to Know

- Basic definitions (section 6.1)
- Node consistency, arc consistency, path consistency (6.2)
- Backtracking search (6.3)
- Variable and value ordering: minimum-remaining values, degree heuristic, least-constraining-value (6.3.1)
- Forward checking (6.3.2)
- Local search for CSPs: min-conflict heuristic (6.4)

Constraint Satisfaction Problems

- What is a CSP?
 - Finite set of variables X_1, X_2, \dots, X_n
 - Nonempty domain of possible values for each variable D_1, D_2, \dots, D_n
 - Finite set of constraints C_1, C_2, \dots, C_m
 - Each constraint C_i limits the values that variables can take,
 - e.g., $X_1 \neq X_2$
 - Each constraint C_i is a pair $\langle \text{scope}, \text{relation} \rangle$
 - Scope = Tuple of variables that participate in the constraint.
 - Relation = List of allowed combinations of variable values.
May be an explicit list of allowed combinations.
May be an abstract relation allowing membership testing and listing.
- CSP benefits
 - Standard representation pattern
 - Generic goal and successor functions
 - Generic heuristics (no domain specific expertise).

Sudoku as a Constraint Satisfaction Problem (CSP)

- Variables: 81 variables
 - $A_1, A_2, A_3, \dots, A_{17}, A_{18}, A_{19}$
 - Letters index rows, top to bottom
 - Digits index columns, left to right

	1	2	3	4	5	6	7	8	9
A		6		1		4		5	
B			8	3		5	6		
C	2								1
D	8			4		7			6
E			6				3		
F	7			9		1			4
G	5								2
H			7	2		6	9		
I		4		5		8		7	

- Domains: The nine positive digits
 - $A_1 \in \{1, 2, 3, 4, 5, 6, 7, 8, 9\}$
 - Etc.
- Constraints: 27 *Alldiff* constraints
 - *Alldiff*($A_1, A_2, A_3, A_4, A_5, A_6, A_7, A_8, A_9$)
 - Etc.

CSPs --- what is a solution?

- A *state* is an *assignment* of values to some or all variables.
 - An assignment is *complete* when every variable has a value.
 - An assignment is *partial* when some variables have no values.
- **Consistent assignment**
 - assignment does not violate the constraints
- A **solution** to a CSP is a complete and consistent assignment.
- Some CSPs require a solution that maximizes an *objective function*.
- Examples of Applications:
 - Scheduling the time of observations on the Hubble Space Telescope
 - Airline schedules
 - Cryptography
 - Computer vision -> image interpretation
 - Scheduling your MS or PhD thesis exam 😊

CSP example: map coloring

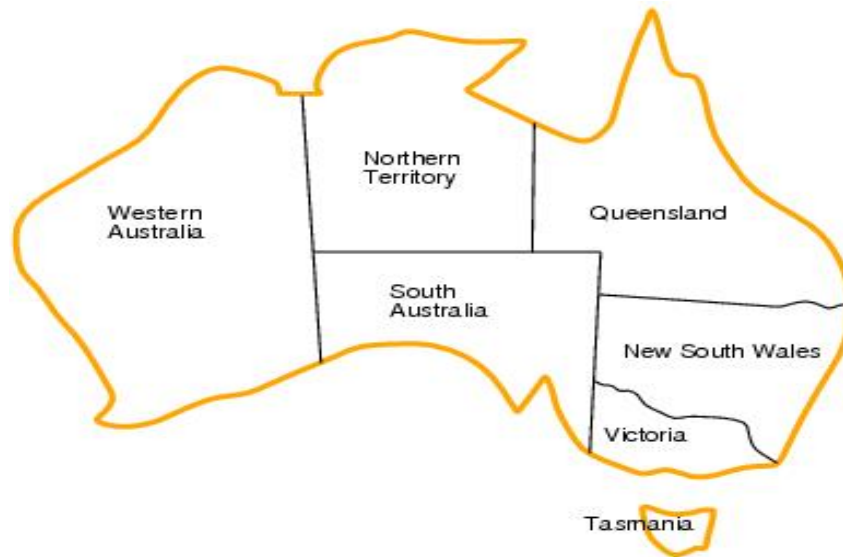

- Variables: WA, NT, Q, NSW, V, SA, T
- Domains: $D_i = \{red, green, blue\}$
- Constraints: adjacent regions must have different colors.
 - E.g. $WA \neq NT$

CSP example: map coloring

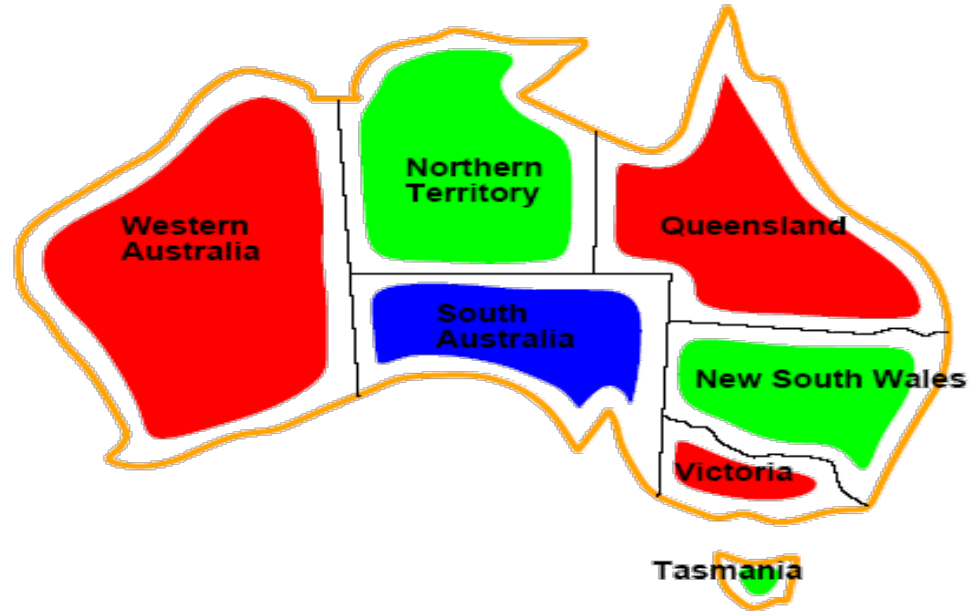

- Solutions are assignments satisfying all constraints, e.g.
 $\{WA=red, NT=green, Q=red, NSW=green, V=red, SA=blue, T=green\}$

Graph coloring

- More general problem than map coloring
- Planar graph = graph in the 2d-plane with no edge crossings
- Guthrie's conjecture (1852)
 - Every planar graph can be colored with 4 colors or less*
 - Proved (using a computer) in 1977 (Appel and Haken)

Constraint graphs

- Constraint graph:
 - nodes are variables
 - arcs are binary constraints

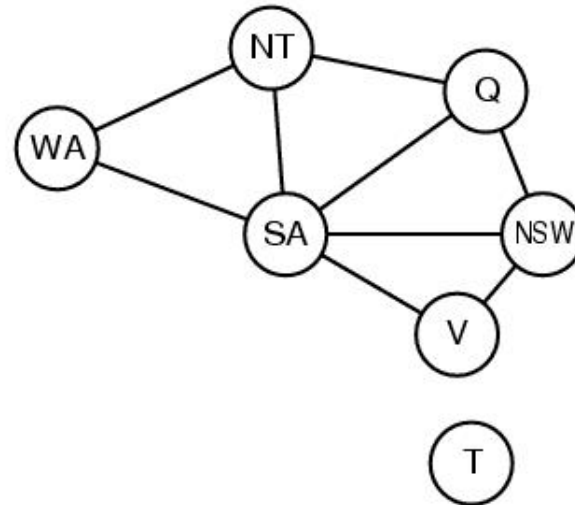

- Graph can be used to simplify search
 - e.g. Tasmania is an independent subproblem
- (will return to graph structure later)

Varieties of CSPs

- Discrete variables
 - Finite domains; size $d \Rightarrow O(d^n)$ complete assignments.
 - E.g. Boolean CSPs: Boolean satisfiability (NP-complete).
 - Infinite domains (integers, strings, etc.)
 - E.g. job scheduling, variables are start/end days for each job
 - Need a constraint language e.g. $StartJob_1 + 5 \leq StartJob_3$.
 - Infinitely many solutions
 - Linear constraints: solvable
 - Nonlinear: no general algorithm
- Continuous variables
 - e.g. building an airline schedule or class schedule.
 - Linear constraints solvable in polynomial time by LP methods.

Varieties of constraints

- Unary constraints involve a single variable.
 - e.g. $SA \neq green$
- Binary constraints involve pairs of variables.
 - e.g. $SA \neq WA$
- Higher-order constraints involve 3 or more variables.
 - Professors A, B, and C cannot be on a committee together
 - Can always be represented by multiple binary constraints
- Preference (soft constraints)
 - e.g. *red* is better than *green* often can be represented by a cost for each variable assignment
 - combination of optimization with CSPs

CSPs Only Need Binary Constraints!!

- Unary constraints: Just delete values from variable's domain.
- Higher order (3 variables or more): reduce to binary constraints.
- Simple example:
 - Three example variables, X, Y, Z .
 - Domains $D_x = \{1, 2, 3\}$, $D_y = \{1, 2, 3\}$, $D_z = \{1, 2, 3\}$.
 - Constraint $C[X, Y, Z] = \{X + Y = Z\} = \{(1, 1, 2), (1, 2, 3), (2, 1, 3)\}$.
 - Plus many other variables and constraints elsewhere in the CSP.

 - Create a new variable, W , taking values as triples (3-tuples).
 - Domain of W is $D_w = \{(1, 1, 2), (1, 2, 3), (2, 1, 3)\}$.
 - D_w is exactly the tuples that satisfy the higher order constraint.
 - Create three new constraints:
 - $C[X, W] = \{ [1, (1, 1, 2)], [1, (1, 2, 3)], [2, (2, 1, 3)] \}$.
 - $C[Y, W] = \{ [1, (1, 1, 2)], [2, (1, 2, 3)], [1, (2, 1, 3)] \}$.
 - $C[Z, W] = \{ [2, (1, 1, 2)], [3, (1, 2, 3)], [3, (2, 1, 3)] \}$.
 - Other constraints elsewhere involving X, Y , or Z are unaffected.

CSP Example: Cryptarithmic puzzle

$$\begin{array}{r} \text{T W O} \\ + \text{T W O} \\ \hline \text{F O U R} \end{array}$$

Variables: $F T U W R O X_1 X_2 X_3$

Domains: $\{0, 1, 2, 3, 4, 5, 6, 7, 8, 9\}$

Constraints

$alldiff(F, T, U, W, R, O)$

$O + O = R + 10 \cdot X_1$, etc.

CSP Example: Cryptarithmic puzzle

$$\begin{array}{r} \text{T W O} \\ + \text{T W O} \\ \hline \text{F O U R} \end{array}$$

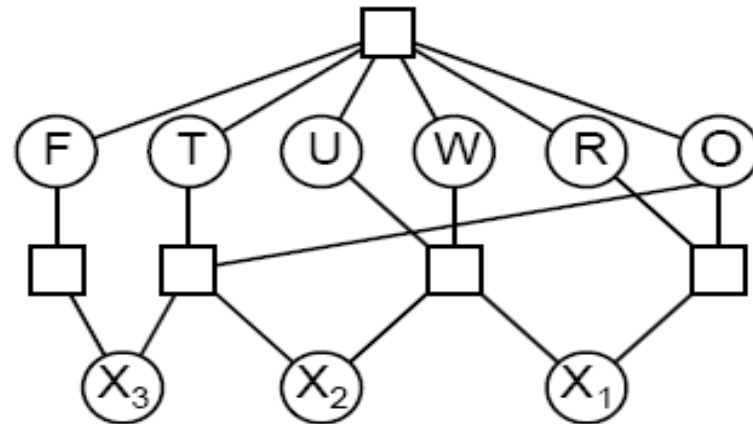

Variables: $F T U W R O X_1 X_2 X_3$

Domains: $\{0, 1, 2, 3, 4, 5, 6, 7, 8, 9\}$

Constraints

$alldiff(F, T, U, W, R, O)$

$O + O = R + 10 \cdot X_1$, etc.

CSP as a standard search problem

- A CSP can easily be expressed as a standard search problem.
- Incremental formulation
 - *Initial State*: the empty assignment { }
 - *Actions* (3rd ed.), *Successor function* (2nd ed.): Assign a value to an unassigned variable provided that it does not violate a constraint
 - *Goal test*: the current assignment is complete
(by construction it is consistent)
 - *Path cost*: constant cost for every step (not really relevant)
- Can also use complete-state formulation
 - Local search techniques (Chapter 4) tend to work well

CSP as a standard search problem

- Solution is found at depth n (if there are n variables).
- Consider using BFS
 - Branching factor b at the top level is nd
 - At next level is $(n-1)d$
 -
- end up with $n!d^n$ leaves even though there are only d^n complete assignments!

Commutativity

- CSPs are commutative.
 - The order of any given set of actions has no effect on the outcome.
 - Example: choose colors for Australian territories one at a time
 - [WA=red then NT=green] same as [NT=green then WA=red]
 - All CSP search algorithms can generate successors by considering assignments for only a single variable at each node in the search tree
 - ⇒ there are d^n leaves
- (will need to figure out later which variable to assign a value to at each node)

Backtracking search

- Similar to Depth-first search, generating children one at a time.
- Chooses values for one variable at a time and backtracks when a variable has no legal values left to assign.
- Uninformed algorithm
 - No good general performance

Backtracking search

function BACKTRACKING-SEARCH(*csp*) **return** a solution or failure
 return RECURSIVE-BACKTRACKING({} , *csp*)

function RECURSIVE-BACKTRACKING(*assignment*, *csp*) **return** a solution or failure
 if *assignment* is complete **then return** *assignment*
 var ← **SELECT-UNASSIGNED-VARIABLE**(VARIABLES[*csp*], *assignment*, *csp*)
 for each *value* **in** **ORDER-DOMAIN-VALUES**(*var*, *assignment*, *csp*) **do**
 if *value* is consistent with *assignment* according to CONSTRAINTS[*csp*]
 then
 add {*var=**value*} to *assignment*
 result ← RECURSIVE-BACKTRACKING(*assignment*, *csp*)
 if *result* ≠ failure **then return** *result*
 remove {*var=**value*} from *assignment*
 return failure

Backtracking search

- Expand *deepest* unexpanded node
- Generate **only one** child at a time.
- *Goal-Test* when inserted.
 - For CSP, Goal-test at bottom

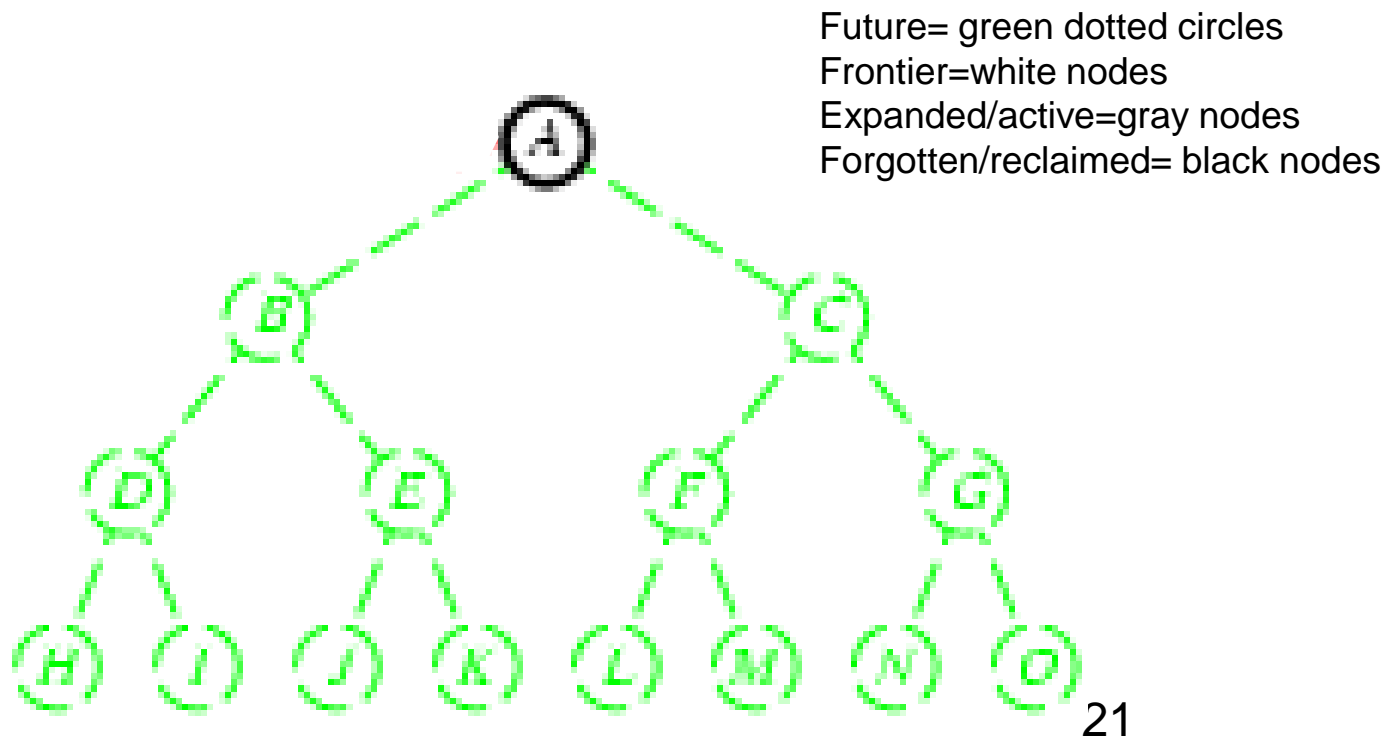

Backtracking search

- Expand *deepest* unexpanded node
- Generate *only one* child at a time.
- *Goal-Test* when inserted.
 - For CSP, Goal-test at bottom

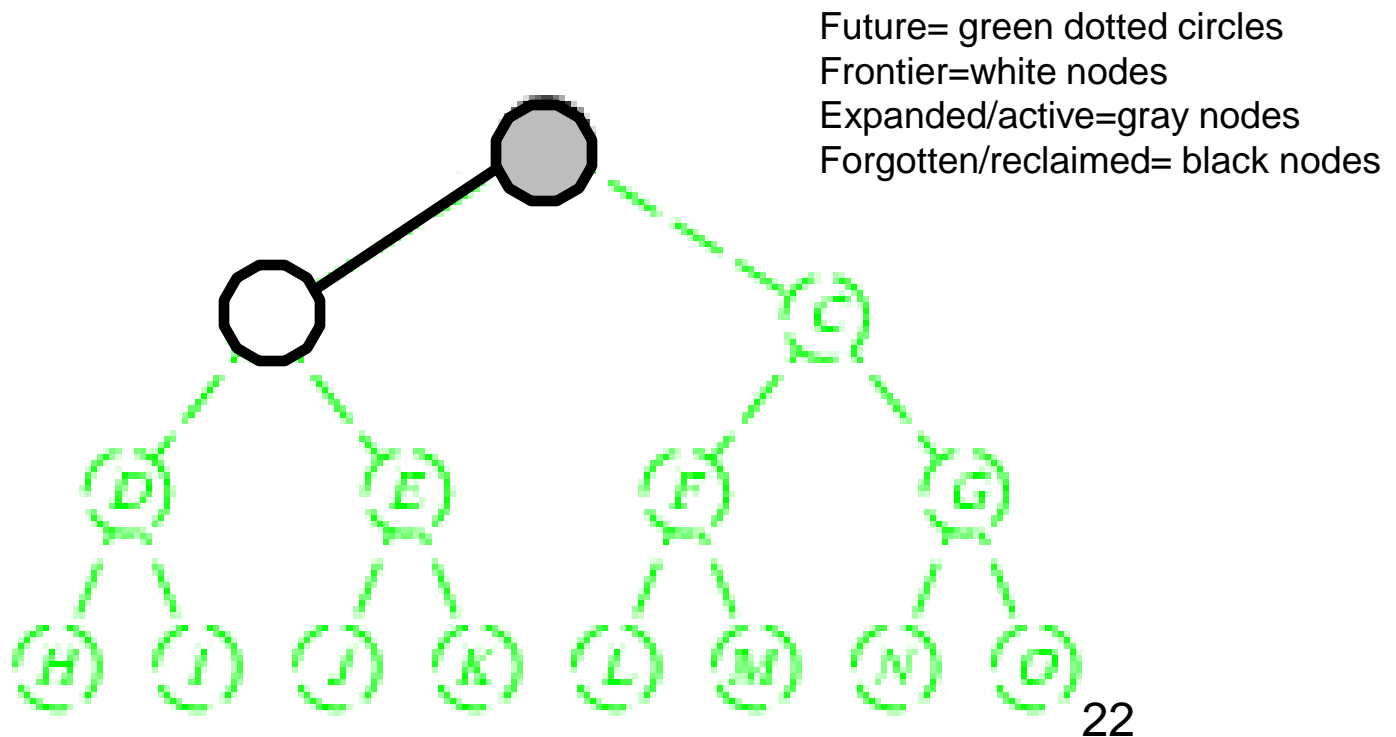

Backtracking search

- Expand *deepest* unexpanded node
- Generate *only one* child at a time.
- *Goal-Test* when inserted.
 - For CSP, Goal-test at bottom

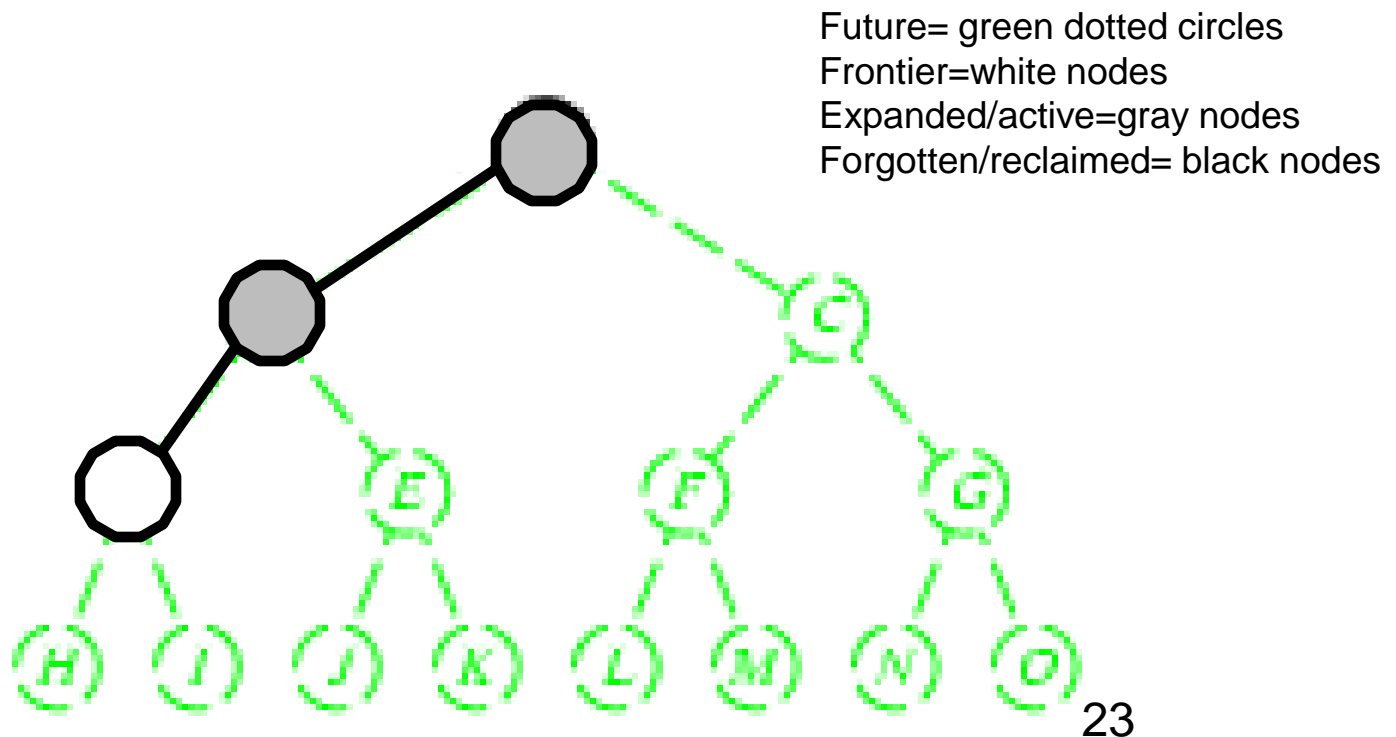

Backtracking search

- Expand *deepest* unexpanded node
- Generate *only one* child at a time.
- *Goal-Test* when inserted.
 - For CSP, Goal-test at bottom

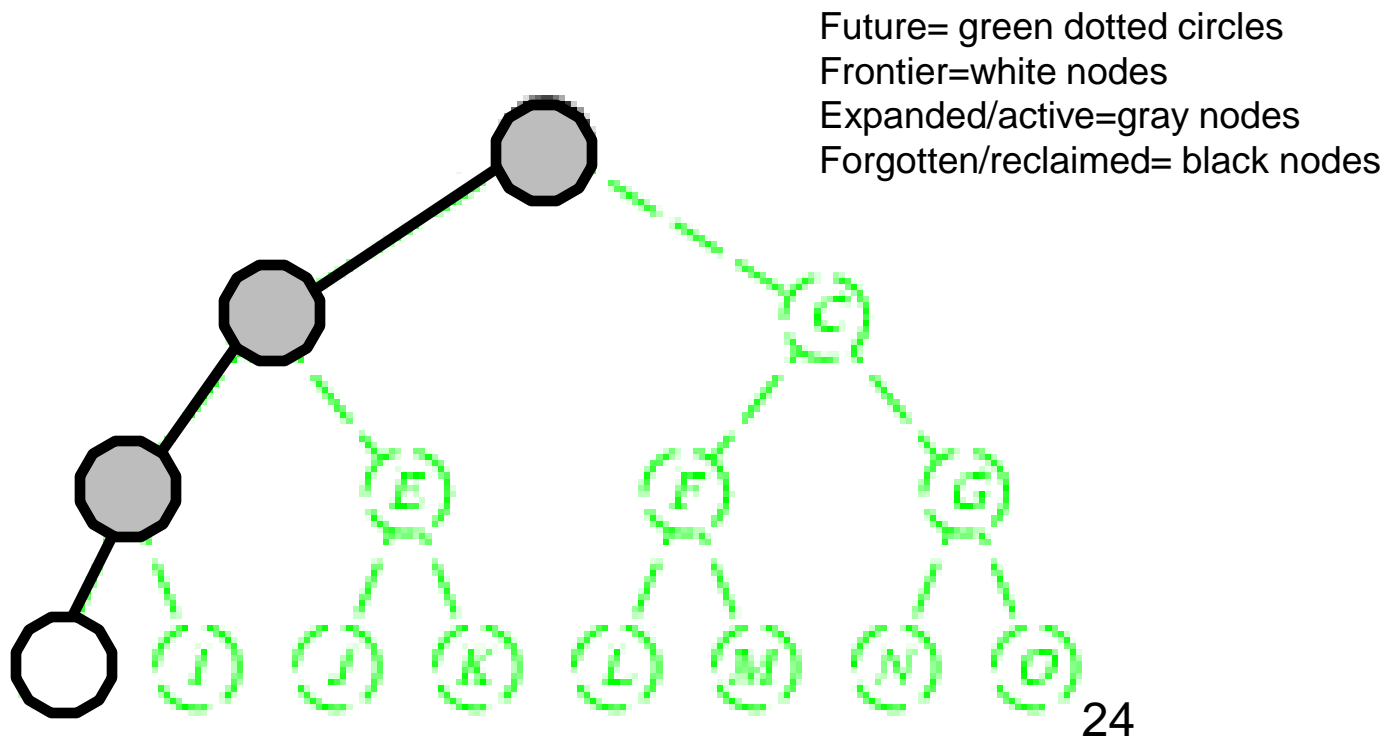

Backtracking search

- Expand *deepest* unexpanded node
- Generate *only one* child at a time.
- *Goal-Test* when inserted.
 - For CSP, Goal-test at bottom

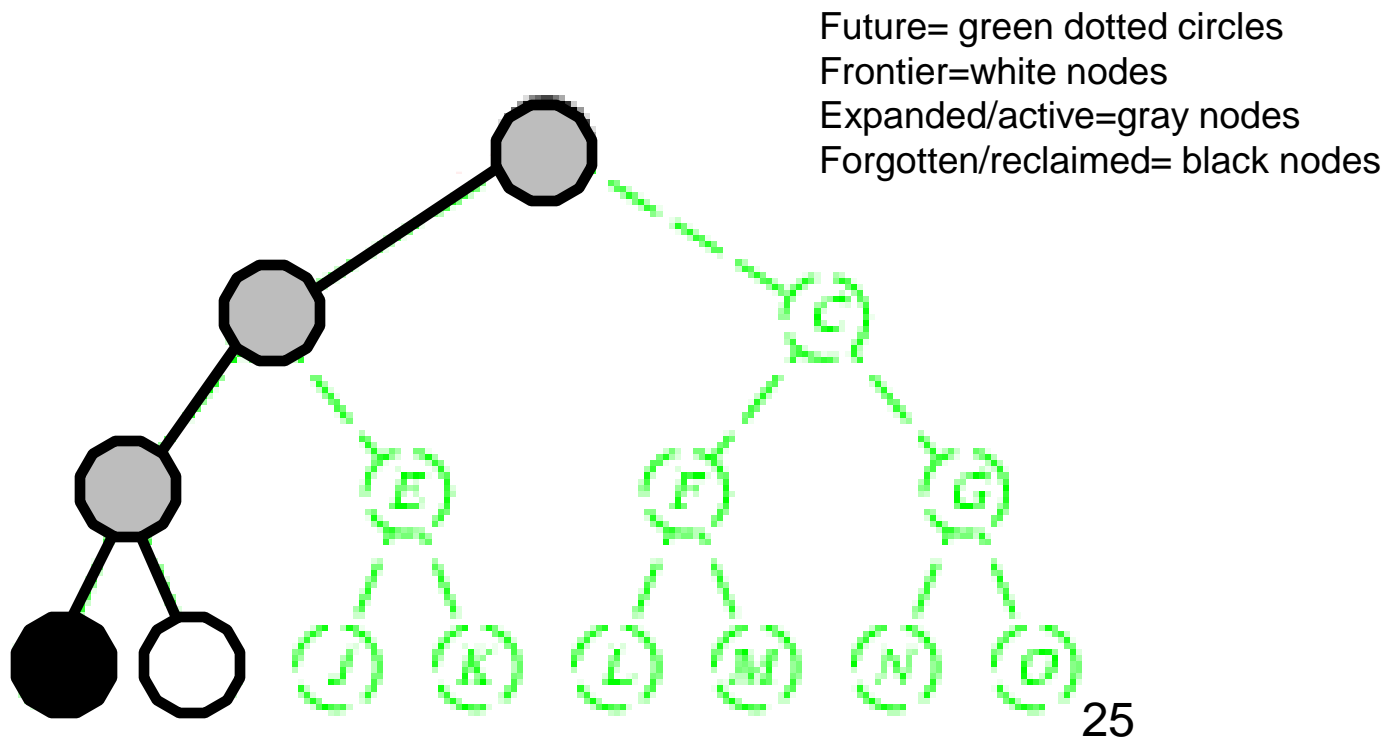

Backtracking search

- Expand *deepest* unexpanded node
- Generate *only one* child at a time.
- *Goal-Test* when inserted.
 - For CSP, Goal-test at bottom

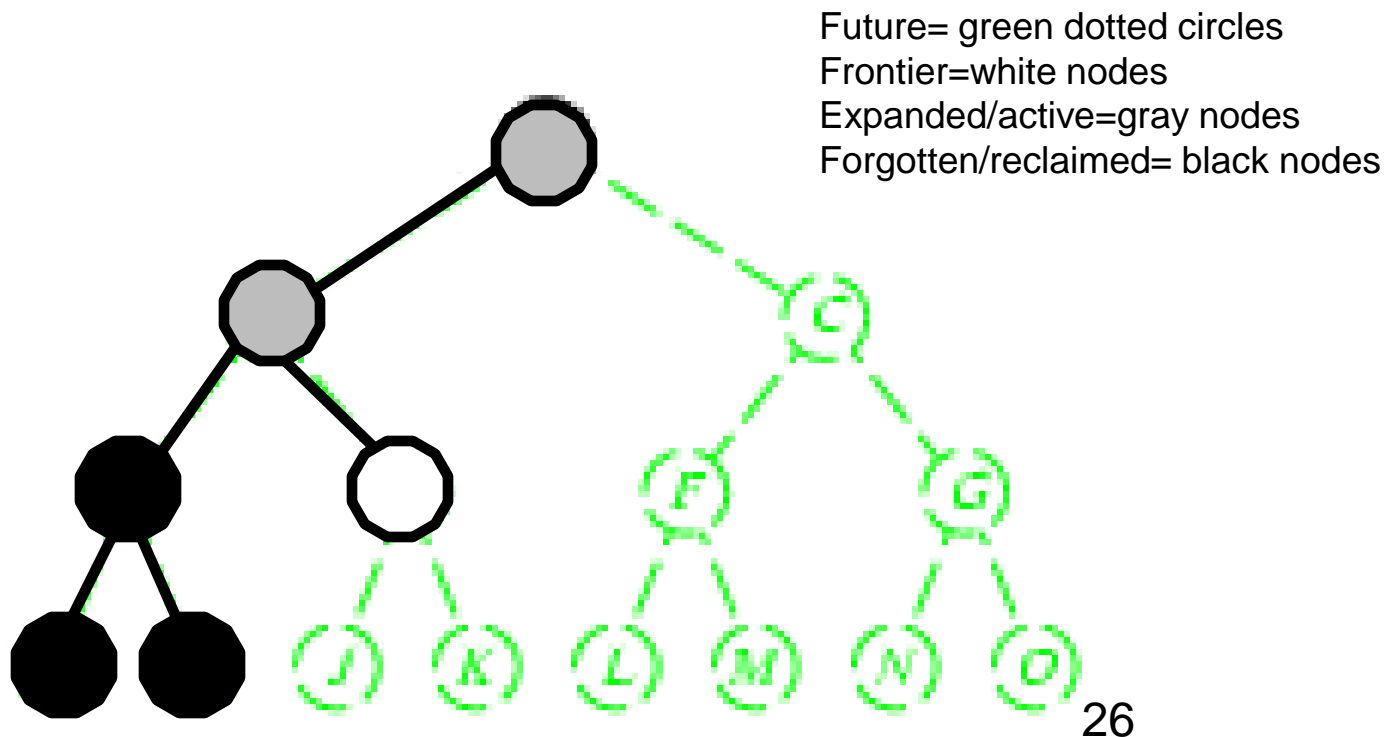

Backtracking search

- Expand *deepest* unexpanded node
- Generate *only one* child at a time.
- *Goal-Test* when inserted.
 - For CSP, Goal-test at bottom

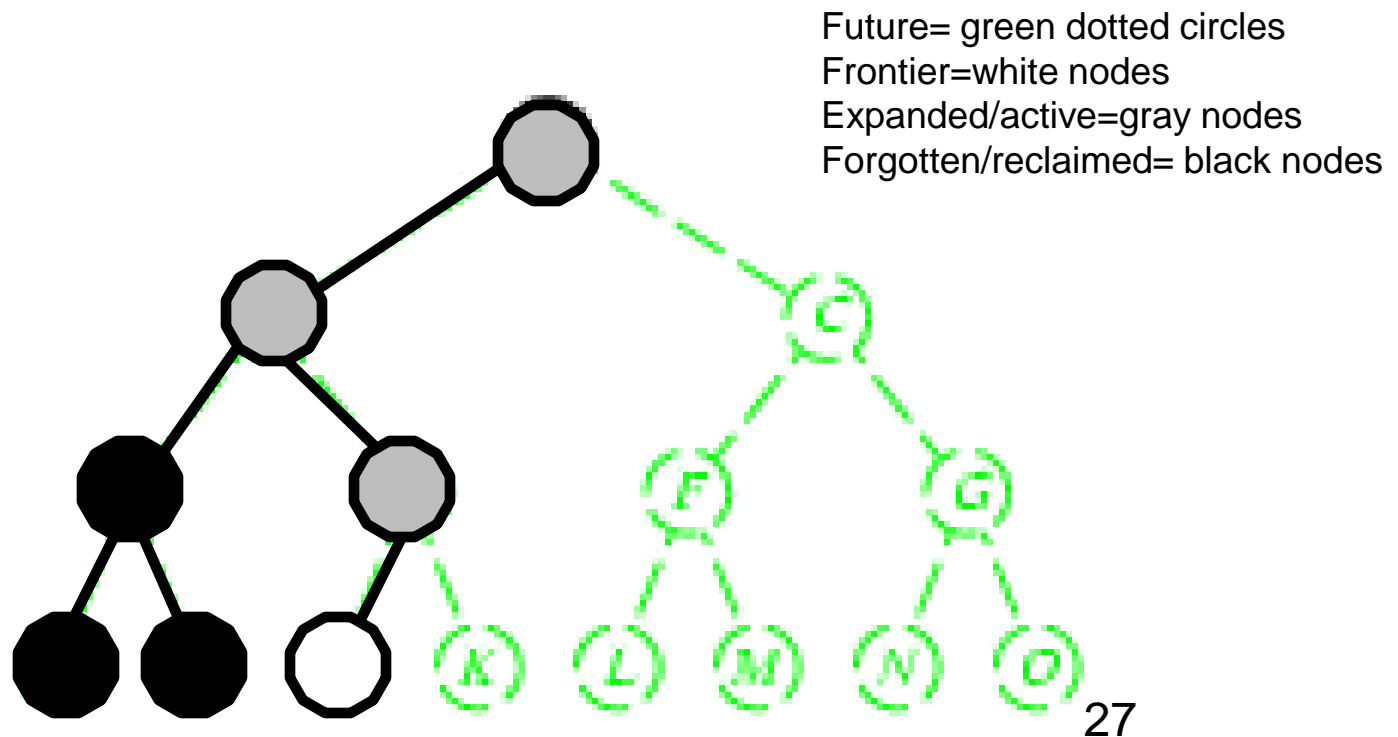

Backtracking search

- Expand *deepest* unexpanded node
- Generate *only one* child at a time.
- *Goal-Test* when inserted.
 - For CSP, Goal-test at bottom

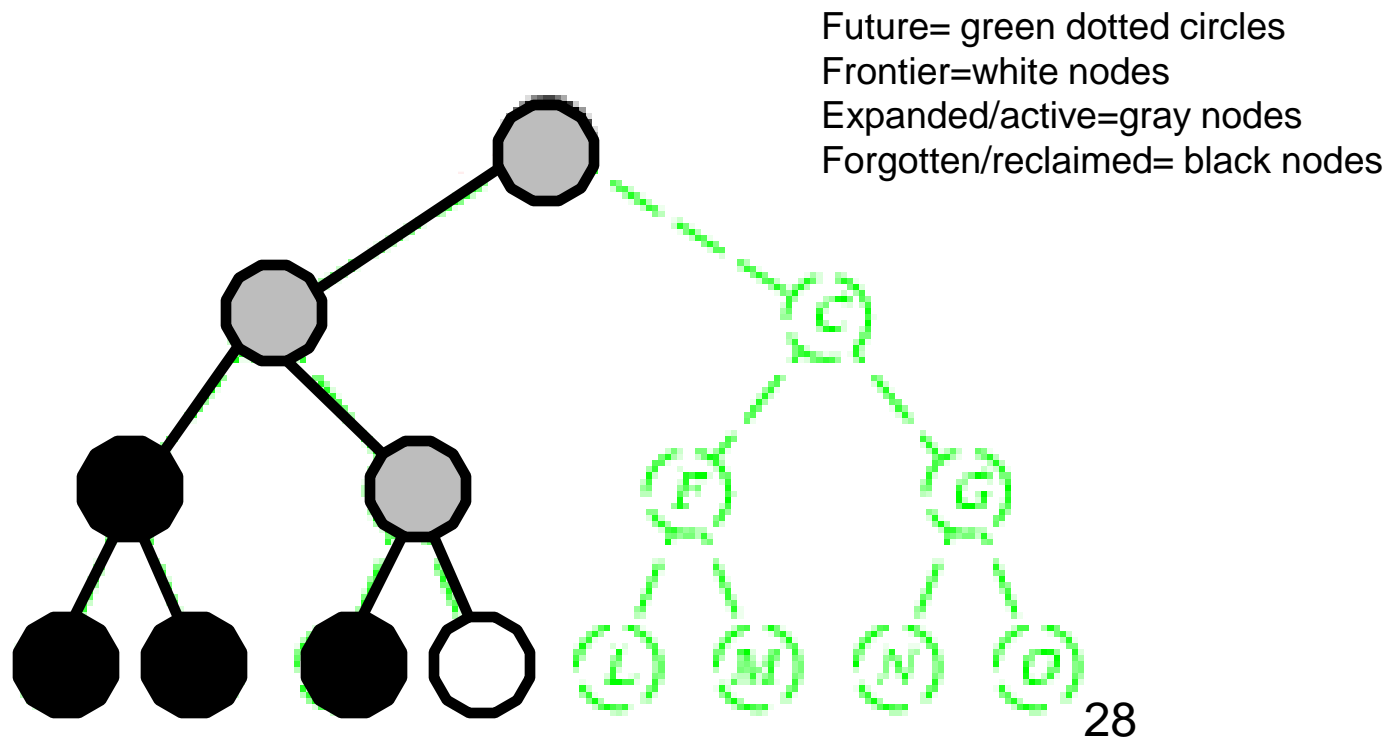

Backtracking search

- Expand *deepest* unexpanded node
- Generate *only one* child at a time.
- *Goal-Test* when inserted.
 - For CSP, Goal-test at bottom

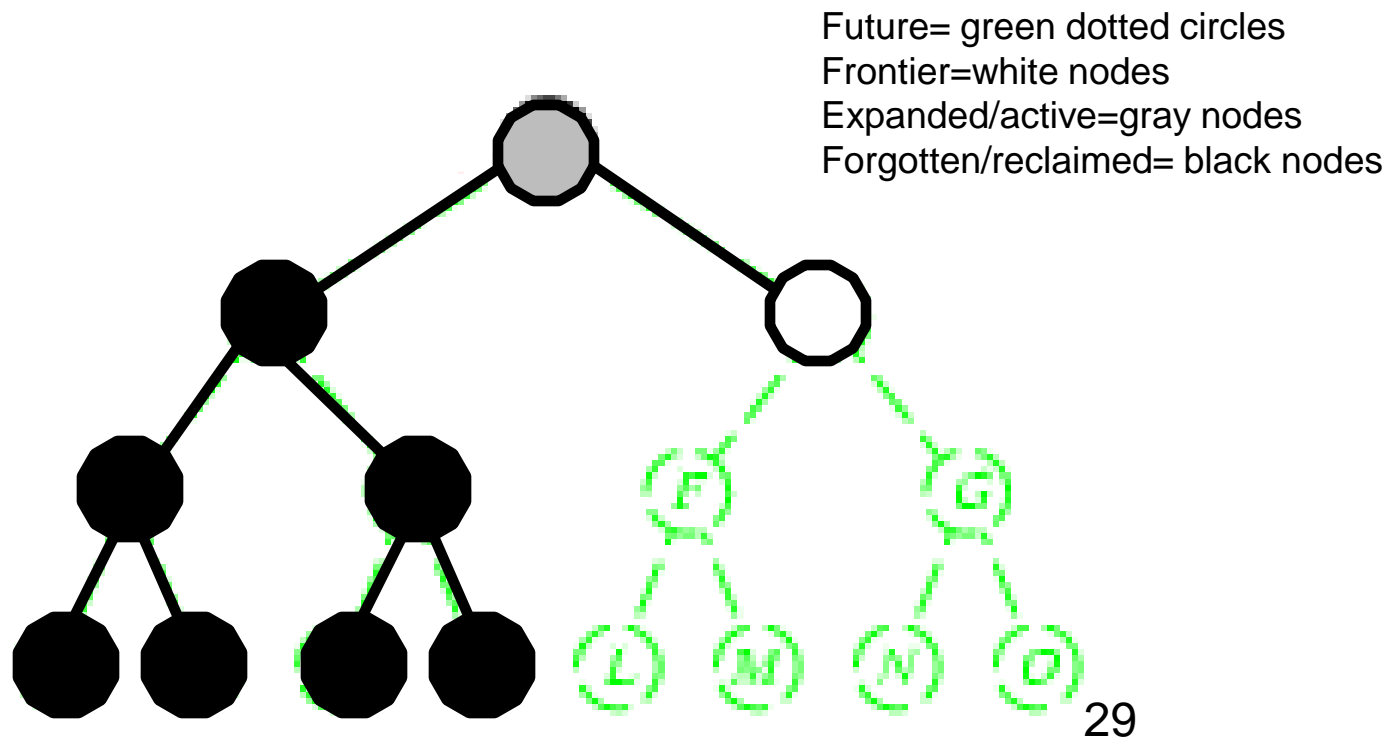

Backtracking search

- Expand *deepest* unexpanded node
- Generate *only one* child at a time.
- *Goal-Test* when inserted.
 - For CSP, Goal-test at bottom

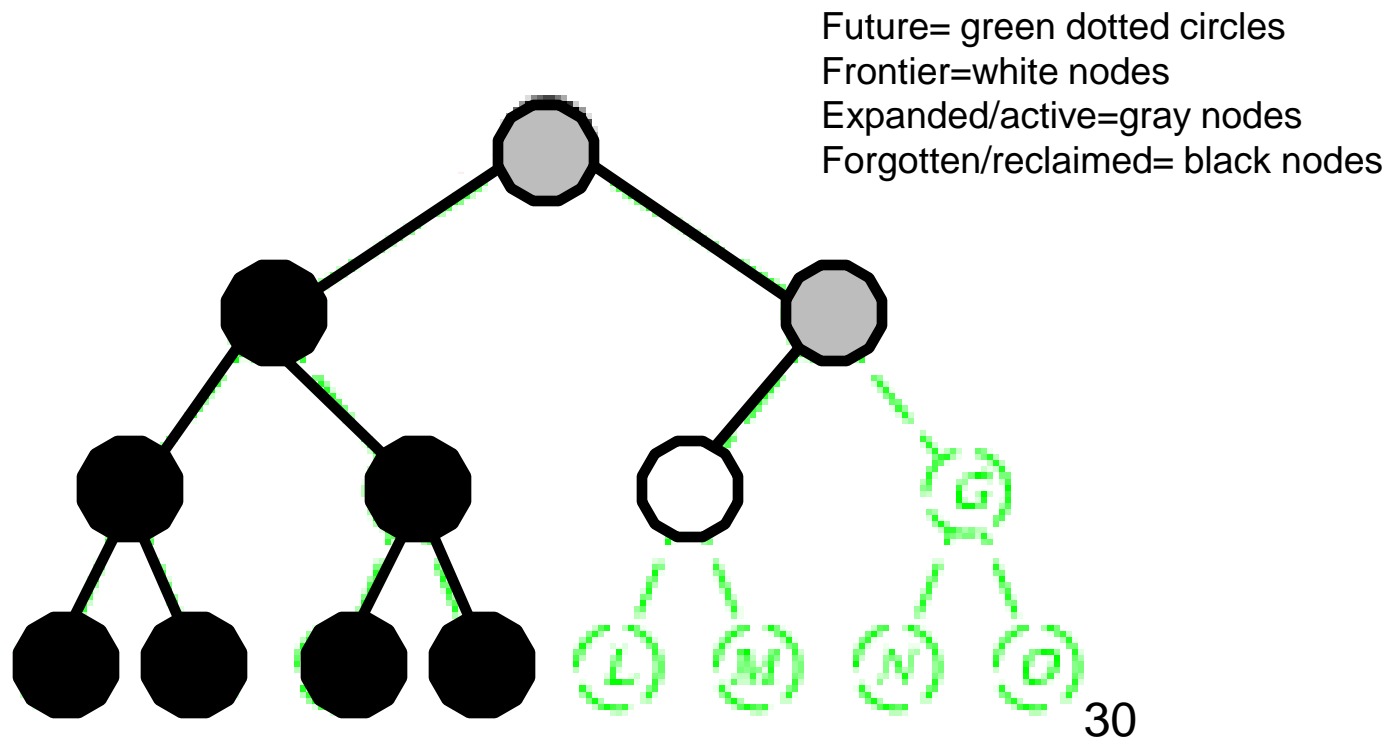

Backtracking search

- Expand *deepest* unexpanded node
- Generate *only one* child at a time.
- *Goal-Test* when inserted.
 - For CSP, Goal-test at bottom

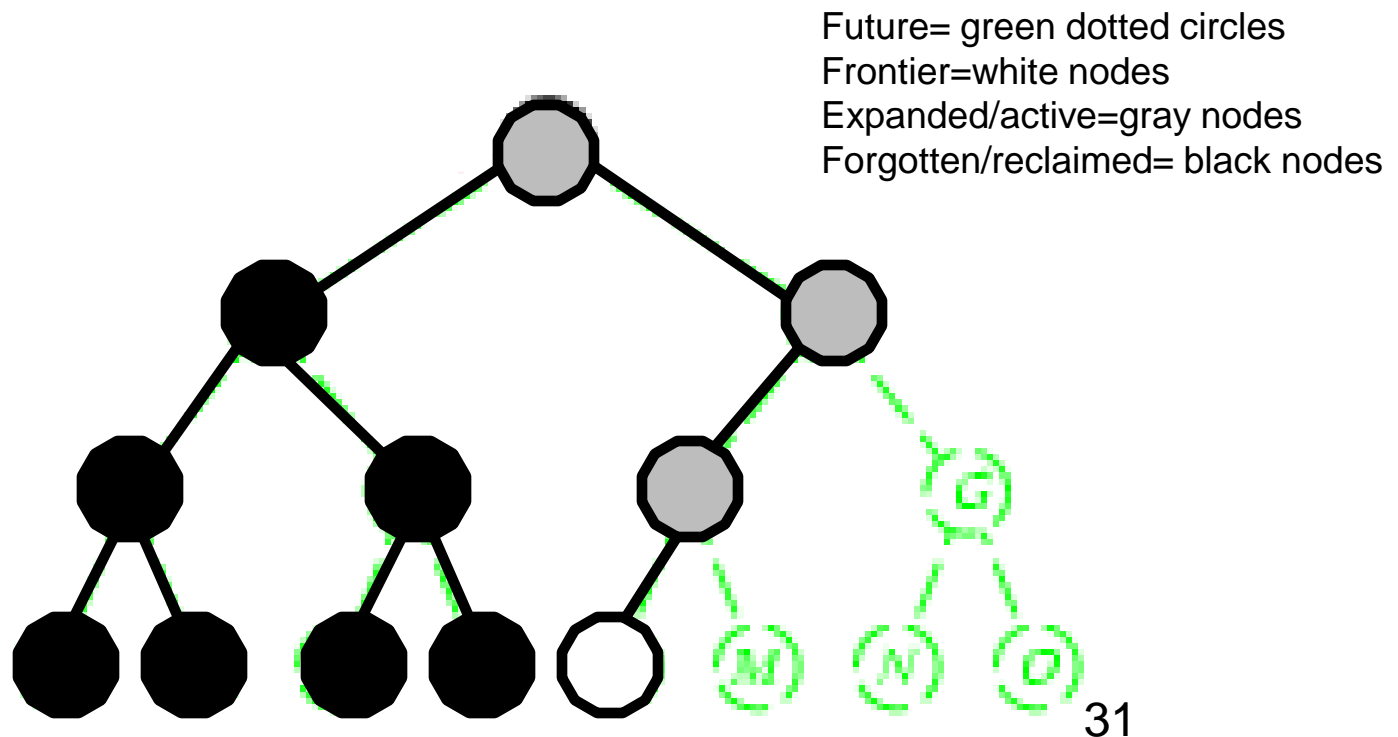

Backtracking search

- Expand *deepest* unexpanded node
- Generate *only one* child at a time.
- *Goal-Test* when inserted.
 - For CSP, Goal-test at bottom

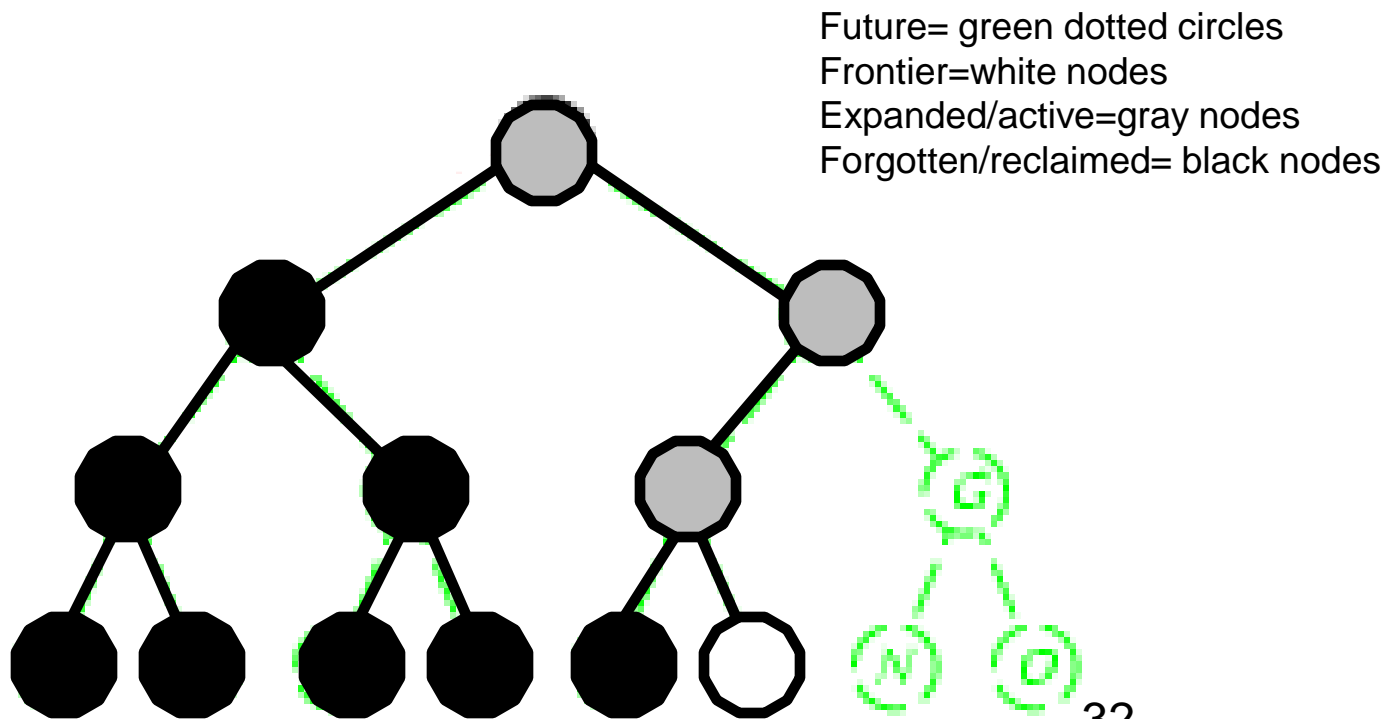

Backtracking search (Figure 6.5)

function BACKTRACKING-SEARCH(*csp*) **return** a solution or failure
return RECURSIVE-BACKTRACKING({} , *csp*)

function RECURSIVE-BACKTRACKING(*assignment*, *csp*) **return** a solution or failure
if *assignment* is complete **then return** *assignment*
var ← **SELECT-UNASSIGNED-VARIABLE(VARIABLES**[*csp*], *assignment*, *csp*)
for each *value* **in** **ORDER-DOMAIN-VALUES**(*var*, *assignment*, *csp*) **do**
 if *value* is consistent with *assignment* according to **CONSTRAINTS**[*csp*]
 then
 add {*var=**value*} to *assignment*
 result ← RECURSIVE-BACKTRACKING(*assignment*, *csp*)
 if *result* ≠ failure **then return** *result*
 remove {*var=**value*} from *assignment*
return *failure*

Comparison of CSP algorithms on different problems

Problem	Backtracking	BT+MRV	Forward Checking	FC+MRV	Min-Conflicts
USA	(> 1,000K)	(> 1,000K)	2K	60	64
<i>n</i> -Queens	(> 40,000K)	13,500K	(> 40,000K)	817K	4K
Zebra	3,859K	1K	35K	0.5K	2K
Random 1	415K	3K	26K	2K	
Random 2	942K	27K	77K	15K	

Median number of consistency checks over 5 runs to solve problem

Parentheses -> no solution found

USA: 4 coloring

n-queens: $n = 2$ to 50

Zebra: see exercise 6.7 (3rd ed.); exercise 5.13 (2nd ed.)

Random Binary CSP

(adapted from <http://www.unitime.org/csp.php>)

- A random binary CSP is defined by a four-tuple (n, d, p_1, p_2)
 - n = the number of variables.
 - d = the domain size of each variable.
 - p_1 = probability a constraint exists between two variables.
 - p_2 = probability a pair of values in the domains of two variables connected by a constraint is incompatible.
 - Note that R&N lists compatible pairs of values instead.
 - Equivalent formulations; just take the set complement.
- (n, d, p_1, p_2) are used to generate randomly the binary constraints among the variables.
- The so called model B of Random CSP (n, d, n_1, n_2)
 - $n_1 = p_1 n(n-1)/2$ pairs of variables are randomly and uniformly selected and binary constraints are posted between them.
 - For each constraint, $n_2 = p_2 d^2$ randomly and uniformly selected pairs of values are picked as incompatible.
- The random CSP as an optimization problem (minCSP).
 - Goal is to minimize the total sum of values for all variables.

Improving CSP efficiency

- Previous improvements on uninformed search
 - introduce heuristics
- For CSPs, general-purpose methods can give large gains in speed, e.g.,
 - Which variable should be assigned next?
 - In what order should its values be tried?
 - Can we detect inevitable failure early?
 - Can we take advantage of problem structure?

Note: CSPs are somewhat generic in their formulation, and so the heuristics are more general compared to methods in Chapter 4

Minimum remaining values (MRV)



$var \leftarrow \text{SELECT-UNASSIGNED-VARIABLE}(\text{VARIABLES}[csp], \text{assignment}, csp)$

- A.k.a. most constrained variable heuristic
- *Heuristic Rule*: choose variable with the fewest legal moves
 - e.g., will immediately detect failure if X has no legal values

Degree heuristic for the initial variable

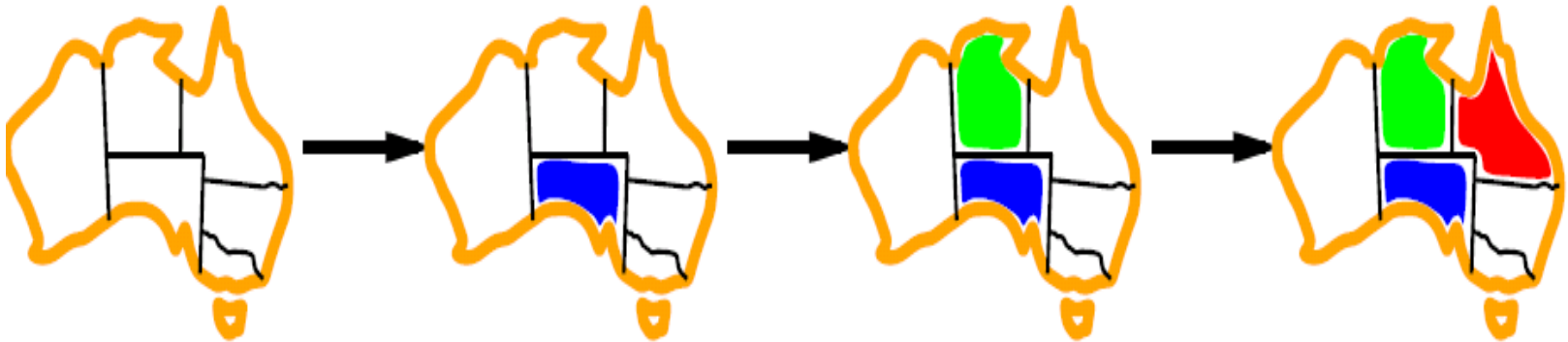

- *Heuristic Rule:* select variable that is involved in the largest number of constraints on other unassigned variables.
- Degree heuristic can be useful as a tie breaker.
- *In what order should a variable's values be tried?*

Least constraining value for value-ordering

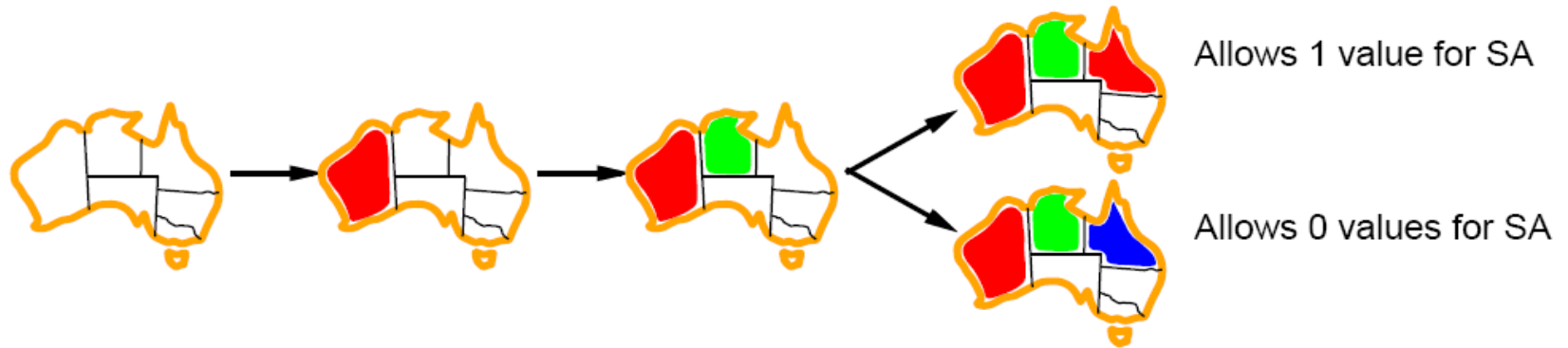

- Least constraining value heuristic
- Heuristic Rule: given a variable choose the least constraining value
 - leaves the maximum flexibility for subsequent variable assignments

Forward checking

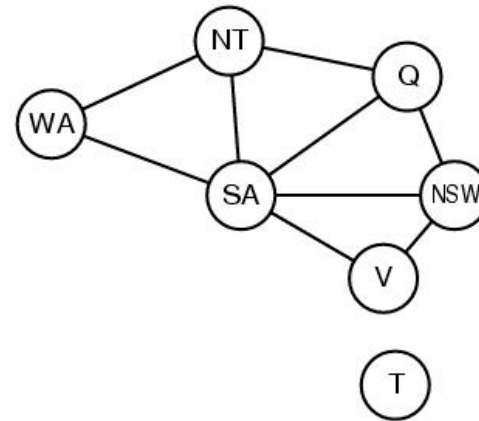

- Can we detect inevitable failure early?
 - *And avoid it later?*
- *Forward checking idea:* keep track of remaining legal values for unassigned variables.
- Terminate search when any variable has no legal values.

Forward checking

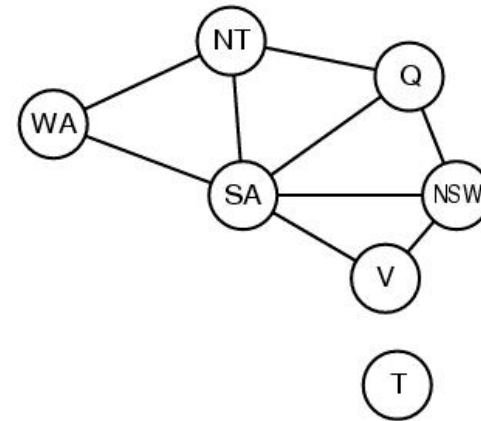
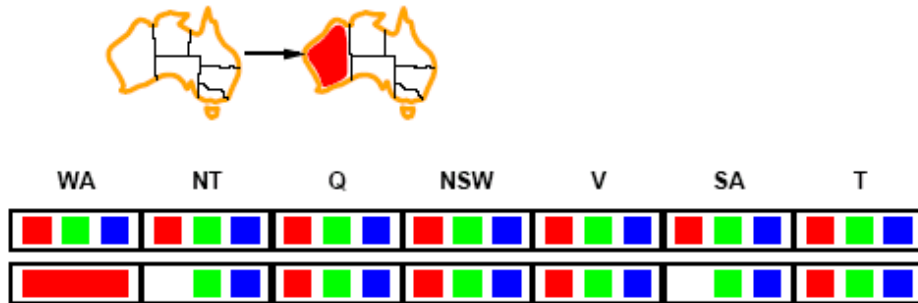

- Assign $\{WA=red\}$
- Effects on other variables connected by constraints to WA
 - *NT can no longer be red*
 - *SA can no longer be red*

Forward checking

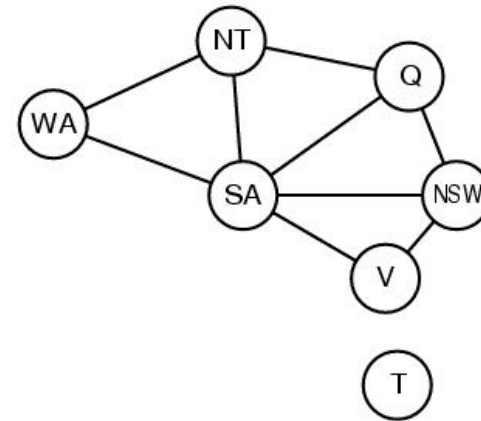
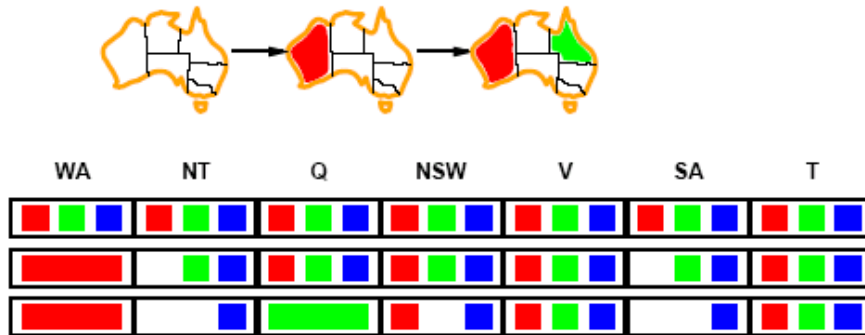

- Assign $\{Q=green\}$
- Effects on other variables connected by constraints with WA
 - *NT can no longer be green*
 - *NSW can no longer be green*
 - *SA can no longer be green*
- *MRV heuristic* would automatically select NT or SA next

Forward checking

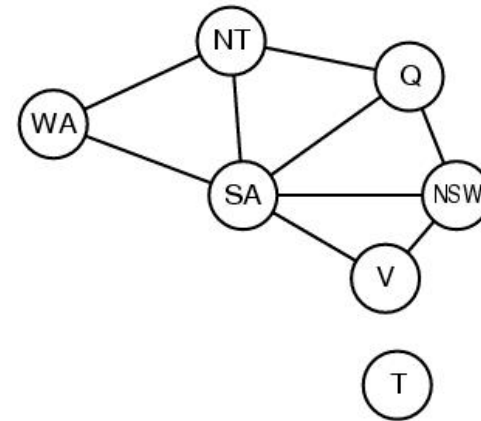
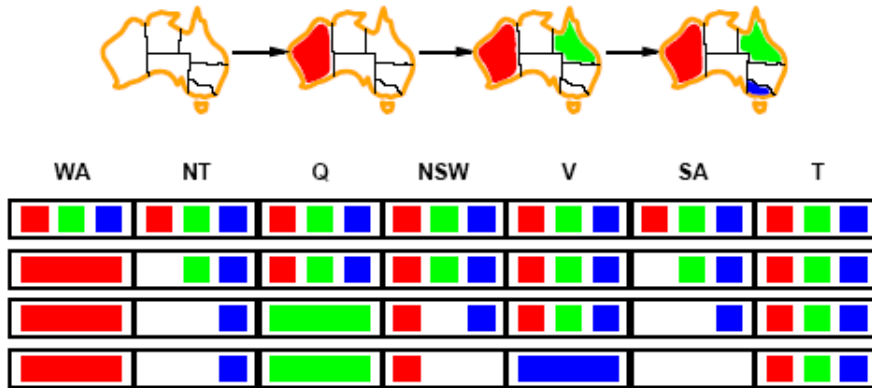

- If *V* is assigned *blue*
- Effects on other variables connected by constraints with *WA*
 - *NSW* can no longer be *blue*
 - *SA* is empty
- FC has detected that partial assignment is *inconsistent* with the constraints and backtracking can occur.

Example: 4-Queens Problem

	X1	X2	X3	X4
1				
2				
3				
4				

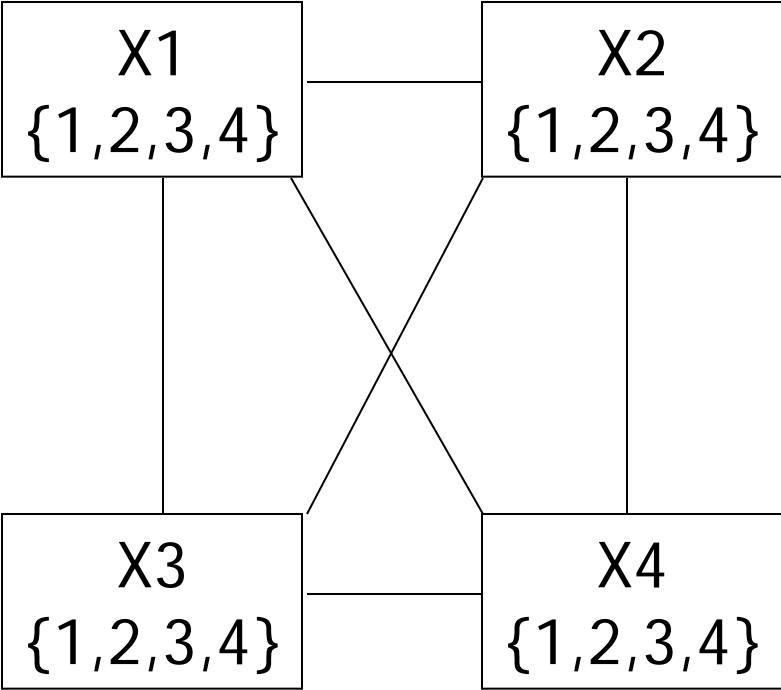

Example: 4-Queens Problem

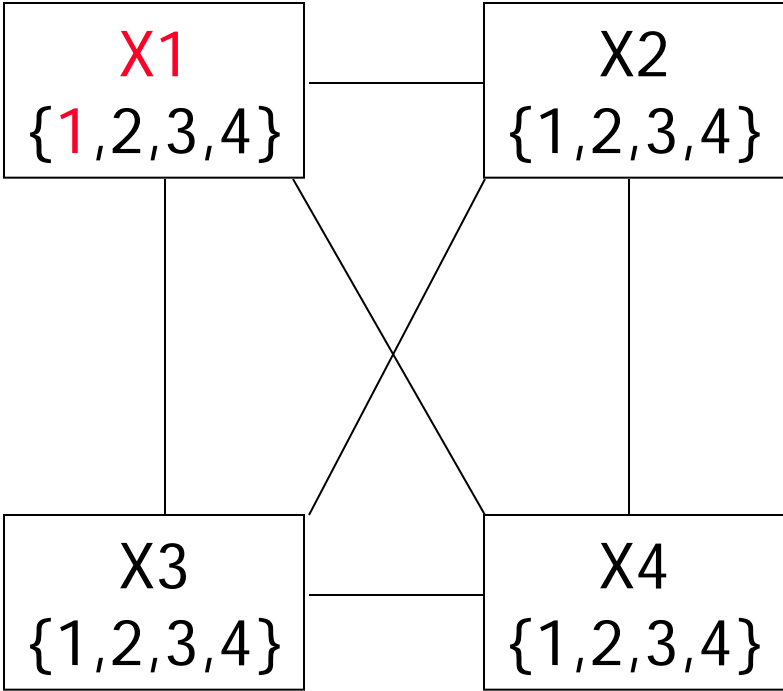
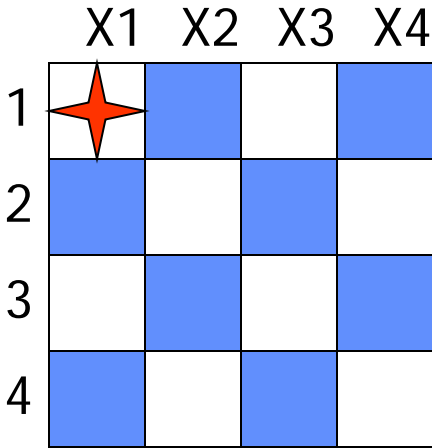

Red = value is assigned to variable

Example: 4-Queens Problem

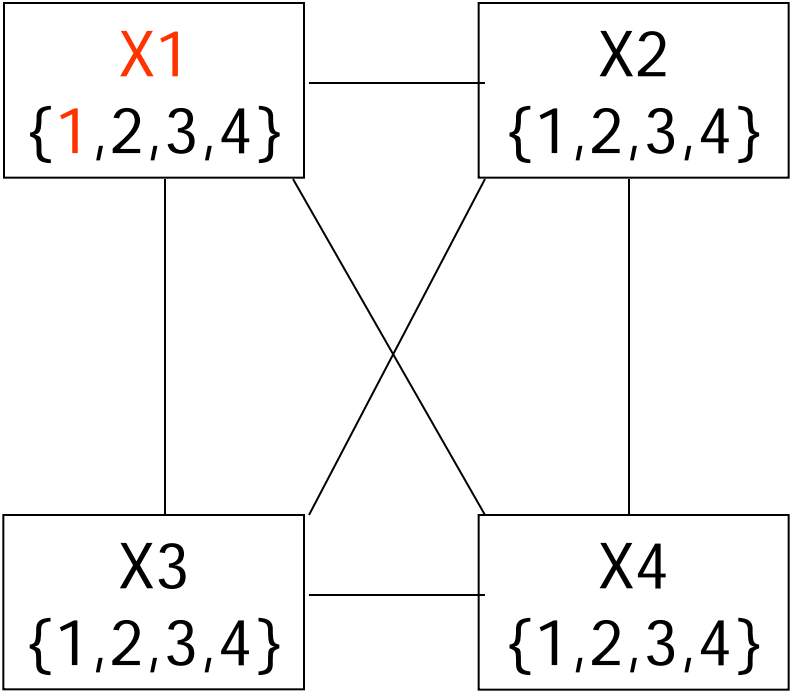
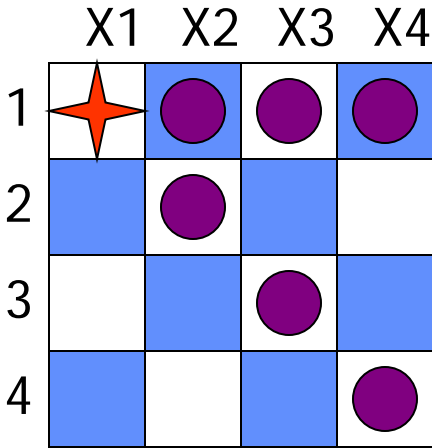

Red = value is assigned to variable

Example: 4-Queens Problem

- X1 Level:
 - Deleted:
 - { (X2,1) (X2,2) (X3,1) (X3,3) (X4,1) (X4,4) }
- (**Please note:** As always in computer science, there are many different ways to implement anything. The book-keeping method shown here was chosen because it is easy to present and understand visually. It is not necessarily the most efficient way to implement the book-keeping in a computer. Your job as an algorithm designer is to think long and hard about your problem, then devise an efficient implementation.)
- One more efficient equivalent possible alternative (of many):
 - Deleted:
 - { (X2:1,2) (X3:1,3) (X4:1,4) }

Example: 4-Queens Problem

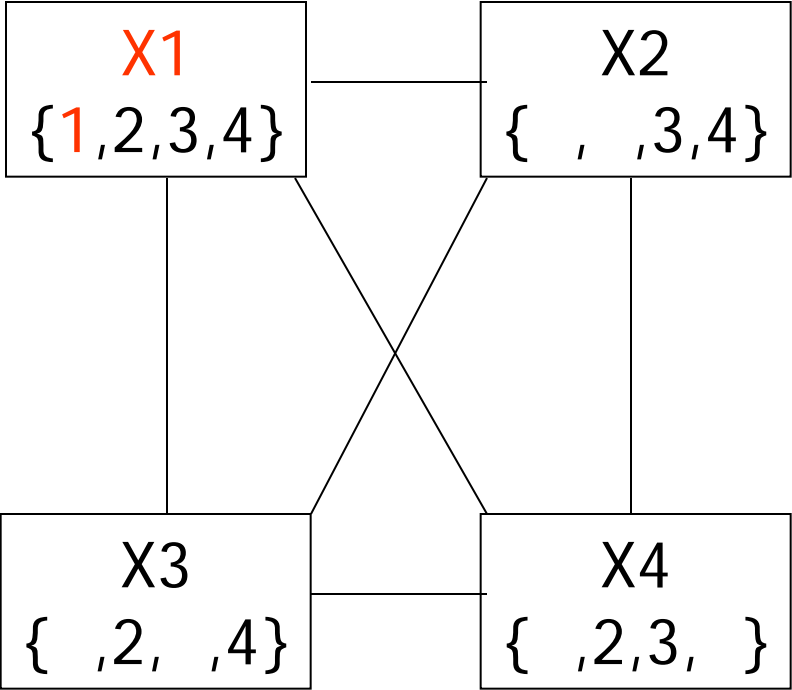
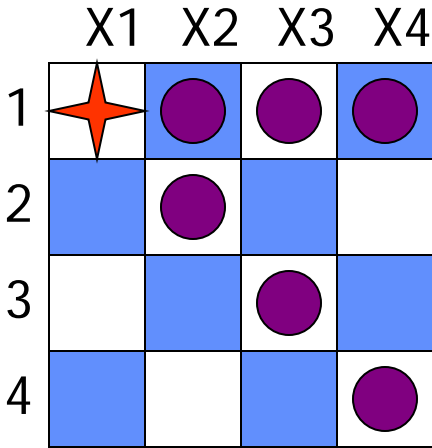

Red = value is assigned to variable

Example: 4-Queens Problem

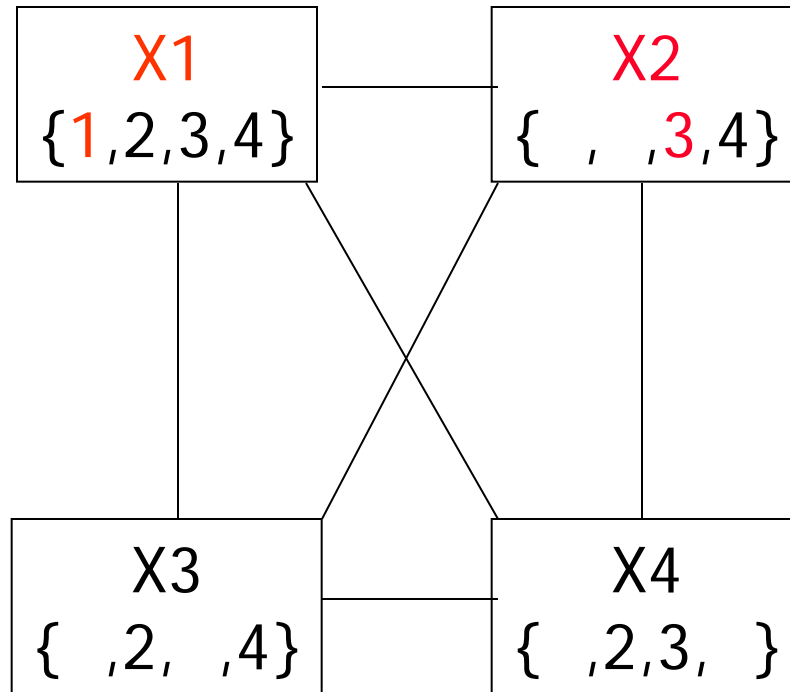
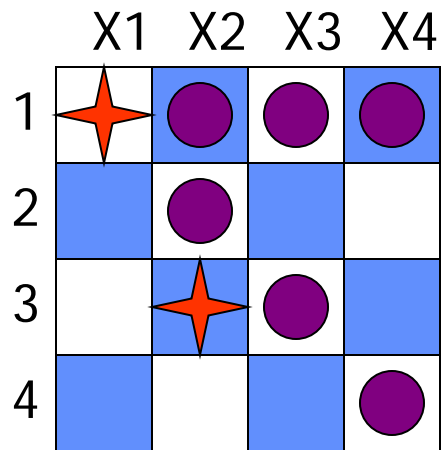

Red = value is assigned to variable

Example: 4-Queens Problem

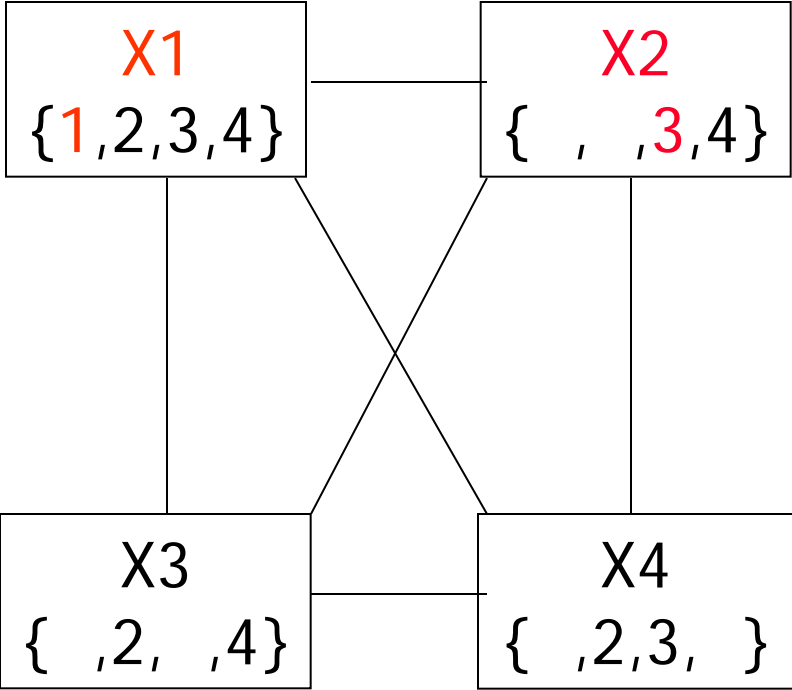
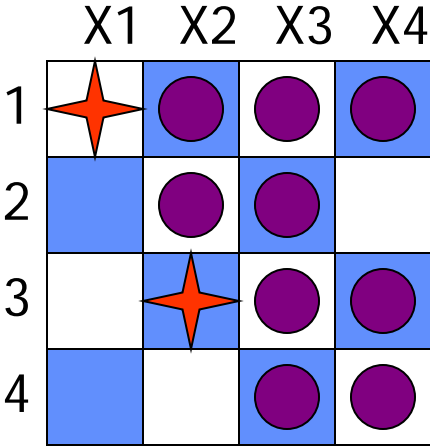

Red = value is assigned to variable

Example: 4-Queens Problem

- X1 Level:
 - Deleted:
 - { (X2,1) (X2,2) (X3,1) (X3,3) (X4,1) (X4,4) }
- X2 Level:
 - Deleted:
 - { (X3,2) (X3,4) (X4,3) }
- (**Please note:** Of course, we could have failed as soon as we deleted { (X3,2) (X3,4) }. There was no need to continue to delete (X4,3), because we already had established that the domain of X3 was null, and so we already knew that this branch was futile and we were going to fail anyway. The book-keeping method shown here was chosen because it is easy to present and understand visually. It is not necessarily the most efficient way to implement the book-keeping in a computer. Your job as an algorithm designer is to think long and hard about your problem, then devise an efficient implementation.)

Example: 4-Queens Problem

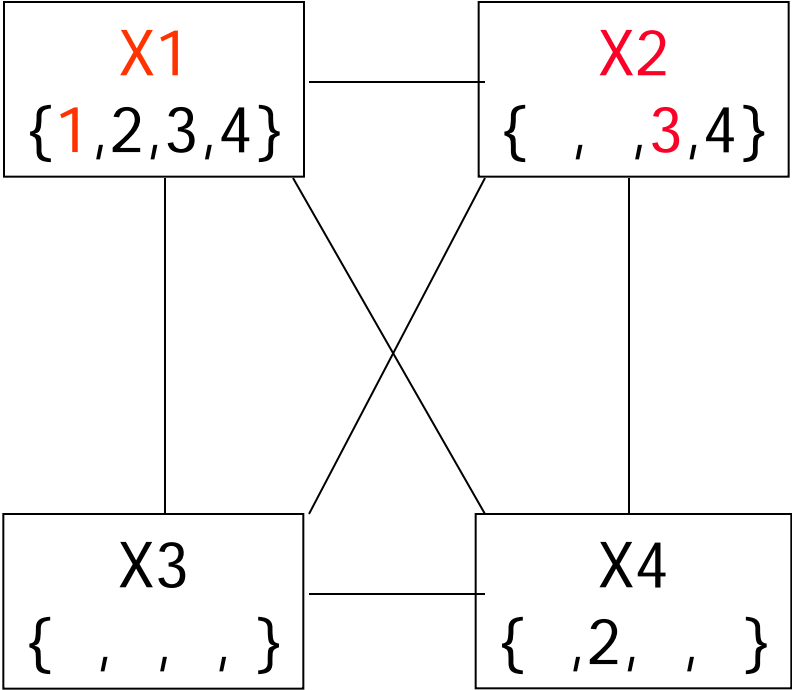
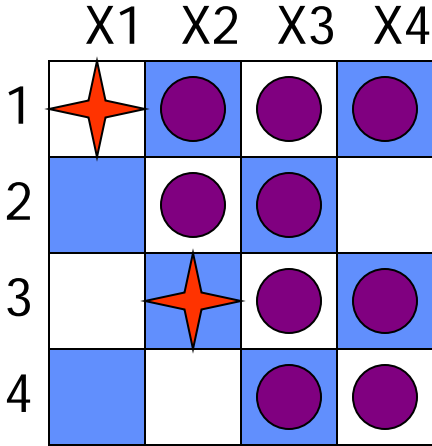

Red = value is assigned to variable

Example: 4-Queens Problem

- X1 Level:
 - Deleted:
 - { (X2,1) (X2,2) (X3,1) (X3,3) (X4,1) (X4,4) }
- X2 Level:
 - **FAIL at X2=3.**
 - **Restore:**
 - { (X3,2) (X3,4) (X4,3) }

Example: 4-Queens Problem

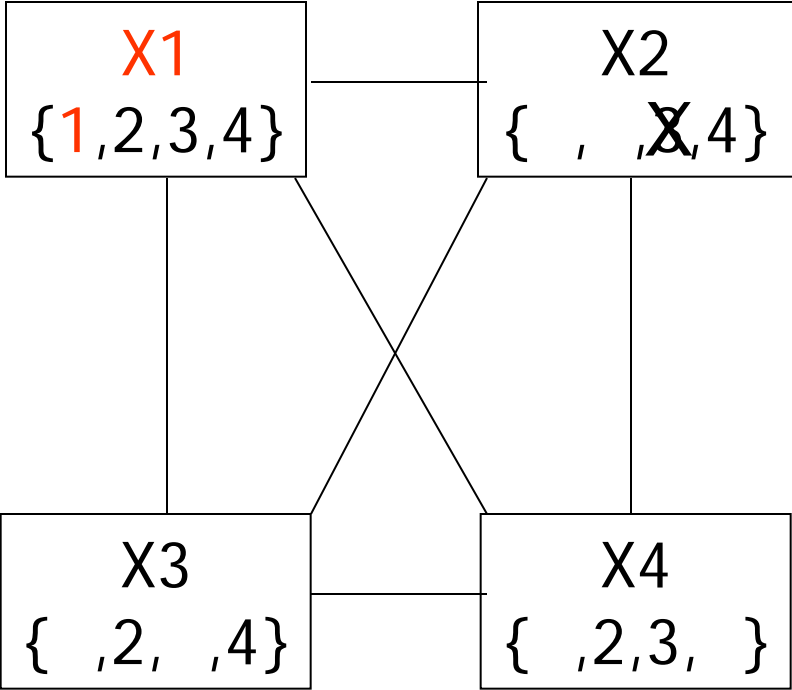
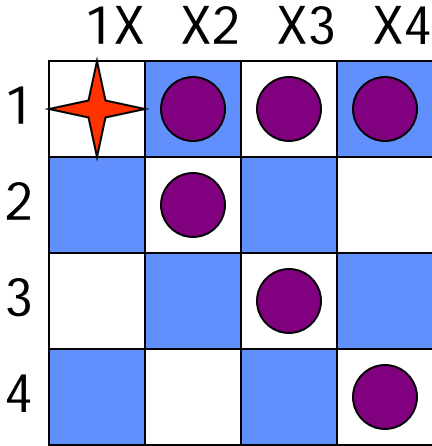

Red = value is assigned to variable
X = value led to failure

Example: 4-Queens Problem

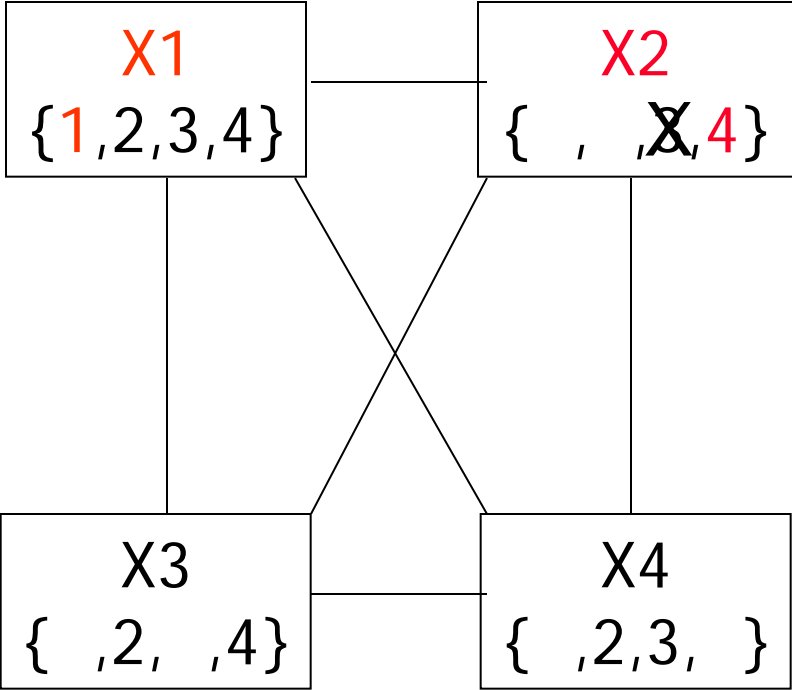
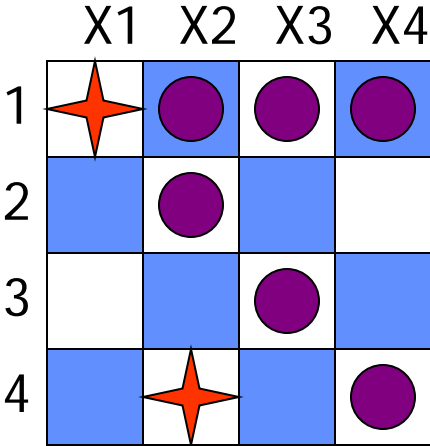

Red = value is assigned to variable
X = value led to failure

Example: 4-Queens Problem

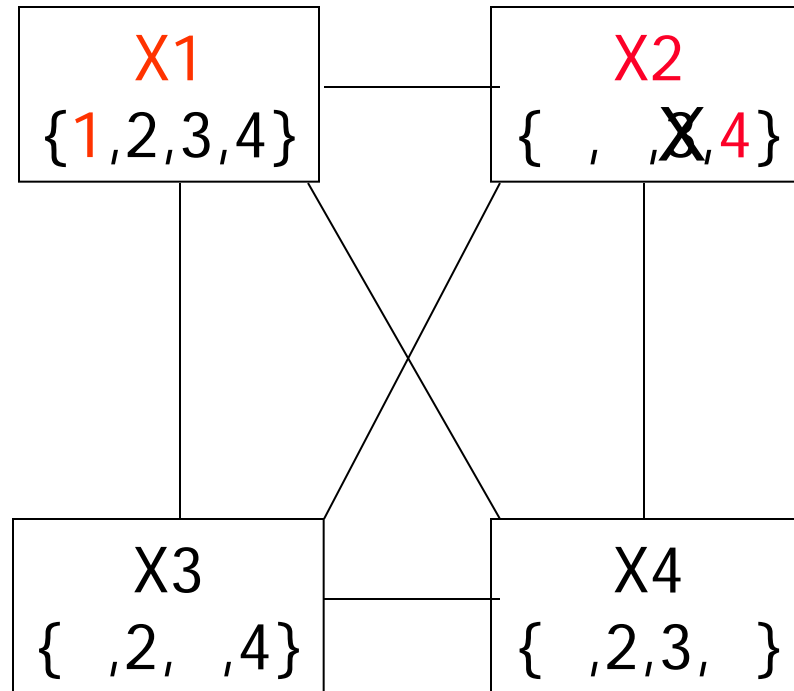
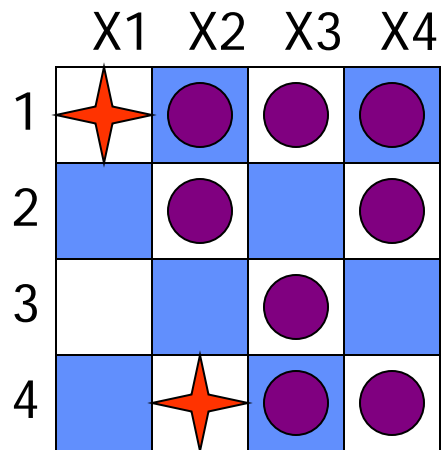

Red = value is assigned to variable
X = value led to failure

Example: 4-Queens Problem

- X1 Level:
 - Deleted:
 - { (X2,1) (X2,2) (X3,1) (X3,3) (X4,1) (X4,4) }
- X2 Level:
 - Deleted:
 - { (X3,4) (X4,2) }

Example: 4-Queens Problem

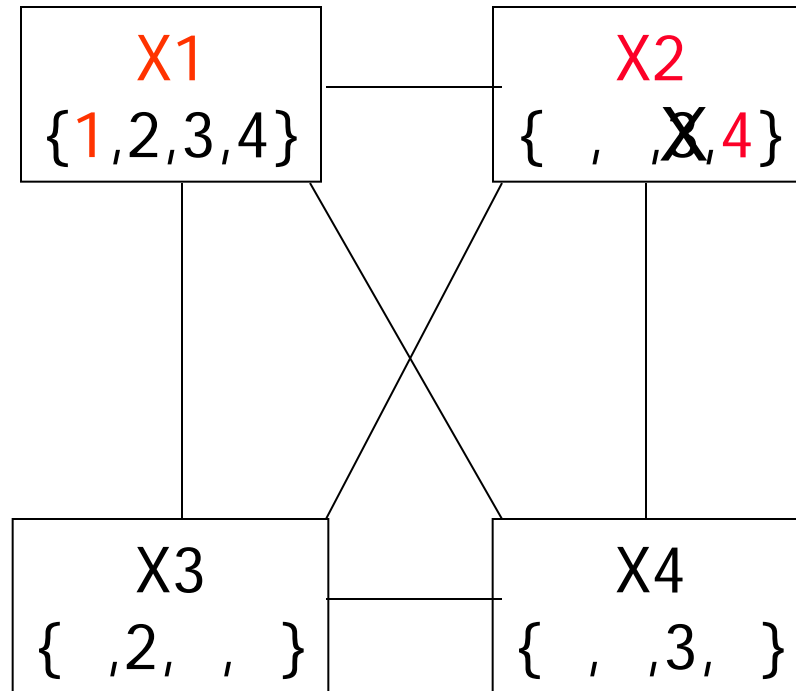
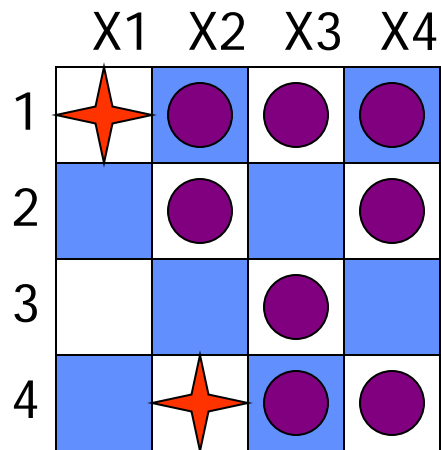

Red = value is assigned to variable
X = value led to failure

Example: 4-Queens Problem

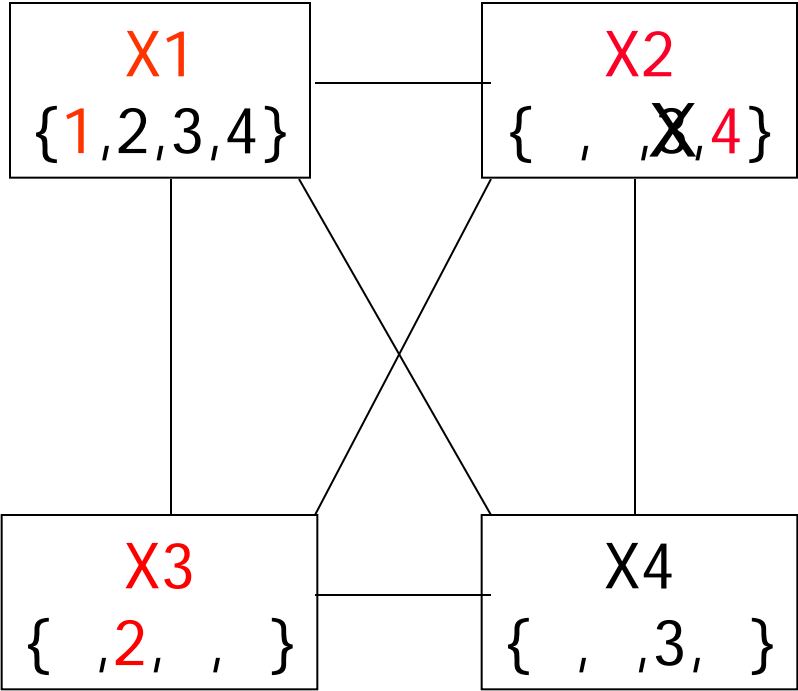
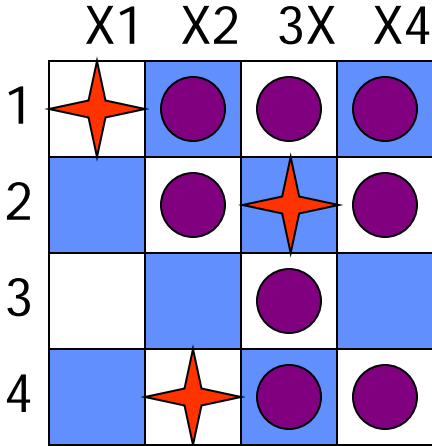

Red = value is assigned to variable
 X = value led to failure

Example: 4-Queens Problem

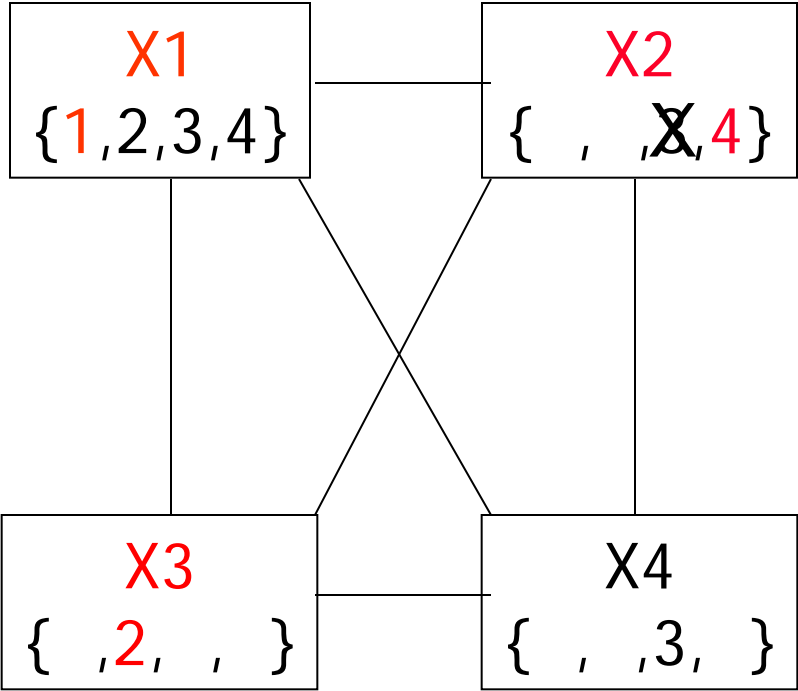
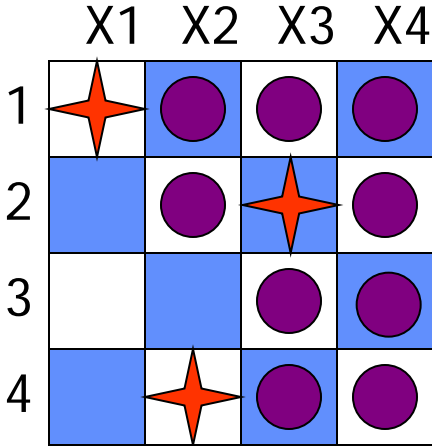

Red = value is assigned to variable
X = value led to failure

Example: 4-Queens Problem

- X1 Level:
 - Deleted:
 - { (X2,1) (X2,2) (X3,1) (X3,3) (X4,1) (X4,4) }
- X2 Level:
 - Deleted:
 - { (X3,4) (X4,2) }
- X3 Level:
 - Deleted:
 - { (X4,3) }

Example: 4-Queens Problem

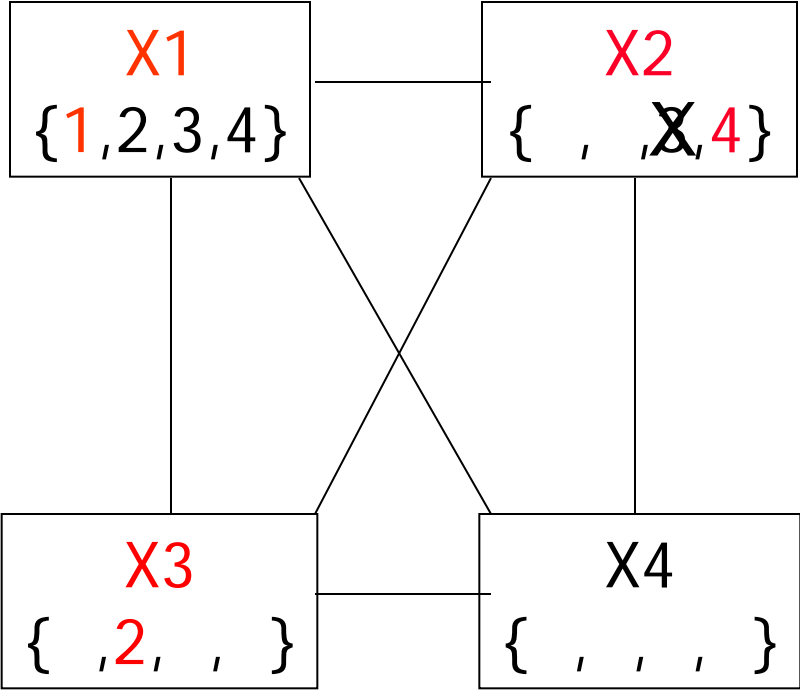
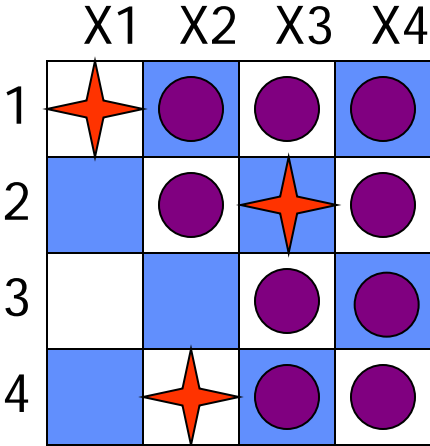

Red = value is assigned to variable
X = value led to failure

Example: 4-Queens Problem

- X1 Level:
 - Deleted:
 - { (X2,1) (X2,2) (X3,1) (X3,3) (X4,1) (X4,4) }
- X2 Level:
 - Deleted:
 - { (X3,4) (X4,2) }
- X3 Level:
 - **Fail at X3=2.**
 - **Restore:**
 - { (X4,3) }

Example: 4-Queens Problem

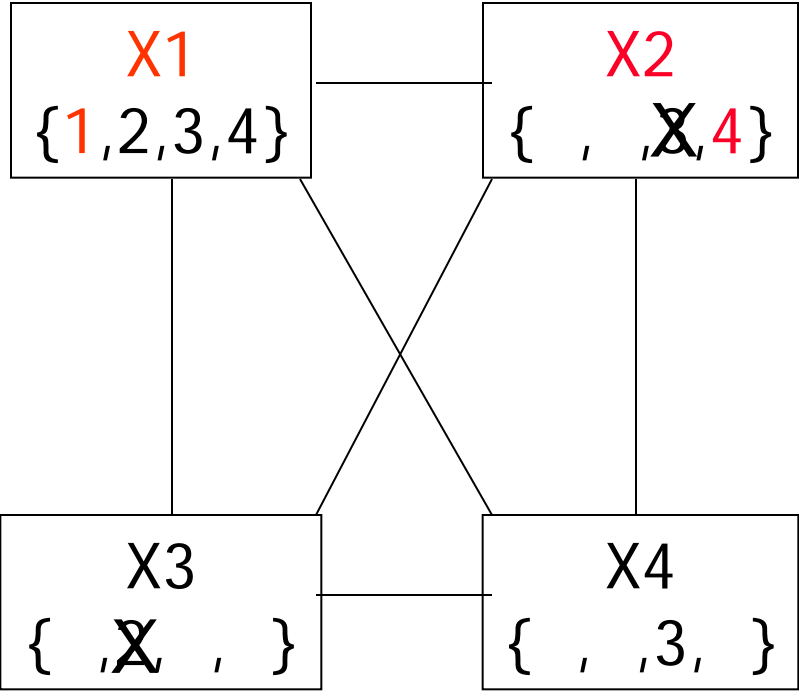
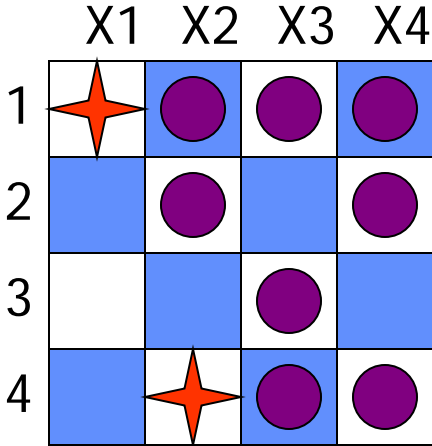

Red = value is assigned to variable
 X = value led to failure

Example: 4-Queens Problem

- X1 Level:
 - Deleted:
 - { (X2,1) (X2,2) (X3,1) (X3,3) (X4,1) (X4,4) }
- X2 Level:
 - **Fail at X2=4.**
 - **Restore:**
 - { (X3,4) (X4,2) }

Example: 4-Queens Problem

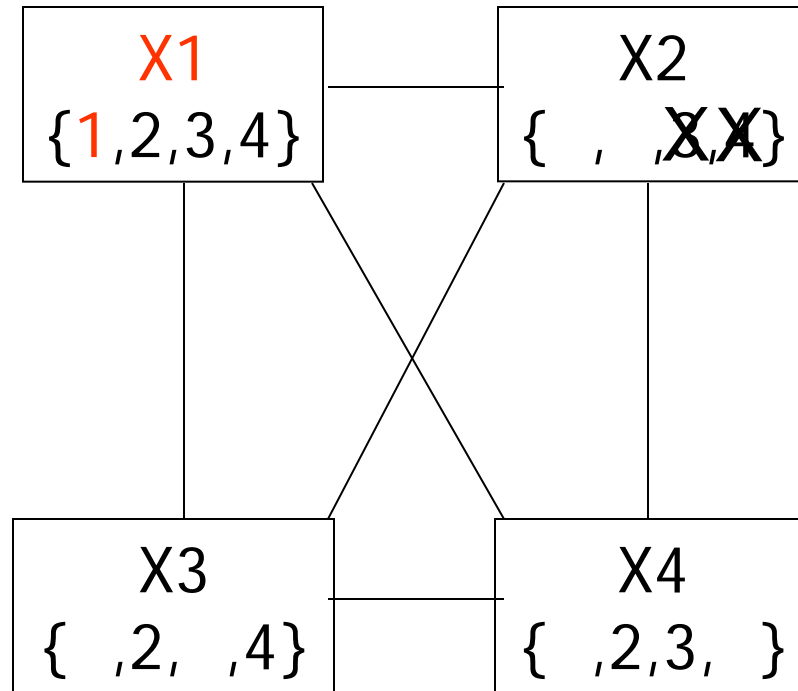
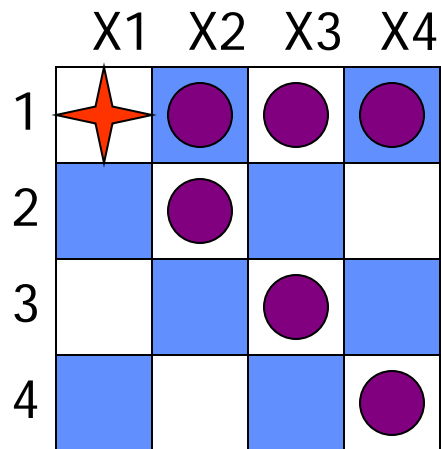

Red = value is assigned to variable
X = value led to failure

Example: 4-Queens Problem

- X1 Level:
 - **Fail at X1=1.**
 - **Restore:**
 - { (X2,1) (X2,2) (X3,1) (X3,3) (X4,1) (X4,4) }

Example: 4-Queens Problem

	X1	X2	X3	X4
1				
2				
3				
4				

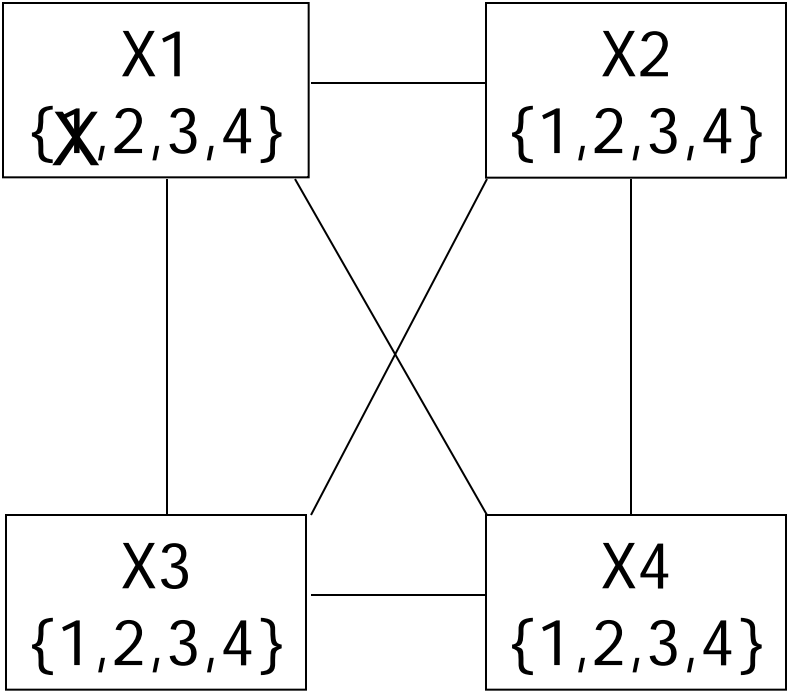

Red = value is assigned to variable
X = value led to failure

Example: 4-Queens Problem

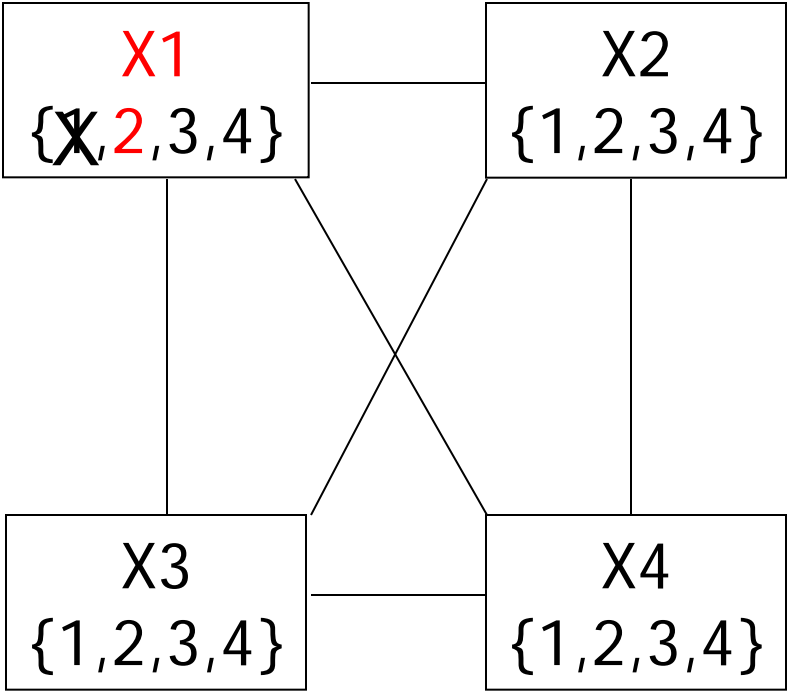
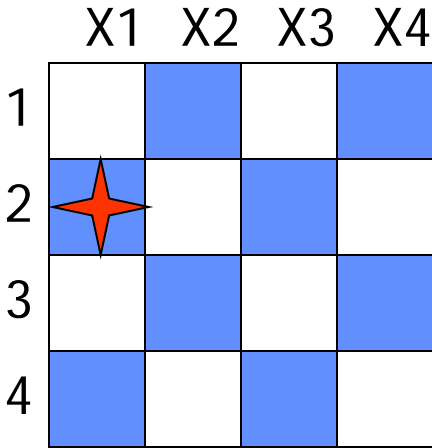

Red = value is assigned to variable
X = value led to failure

Example: 4-Queens Problem

	X1	X2	X3	X4
1		●		
2	★	●	●	●
3		●		
4			●	

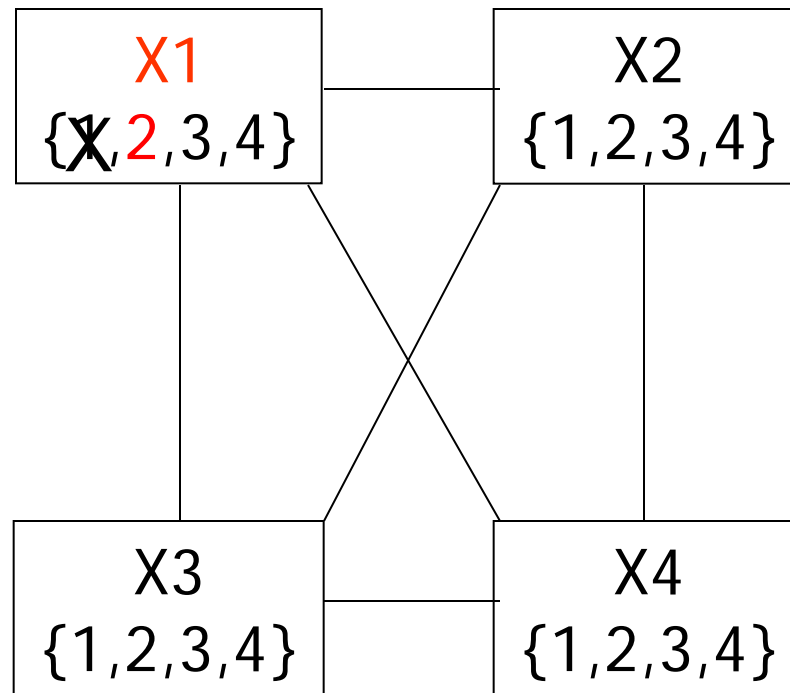

Red = value is assigned to variable

X = value led to failure

Example: 4-Queens Problem

- X1 Level:
 - Deleted:
 - { (X2,1) (X2,2) (X2,3) (X3,2) (X3,4) (X4,2) }

Example: 4-Queens Problem

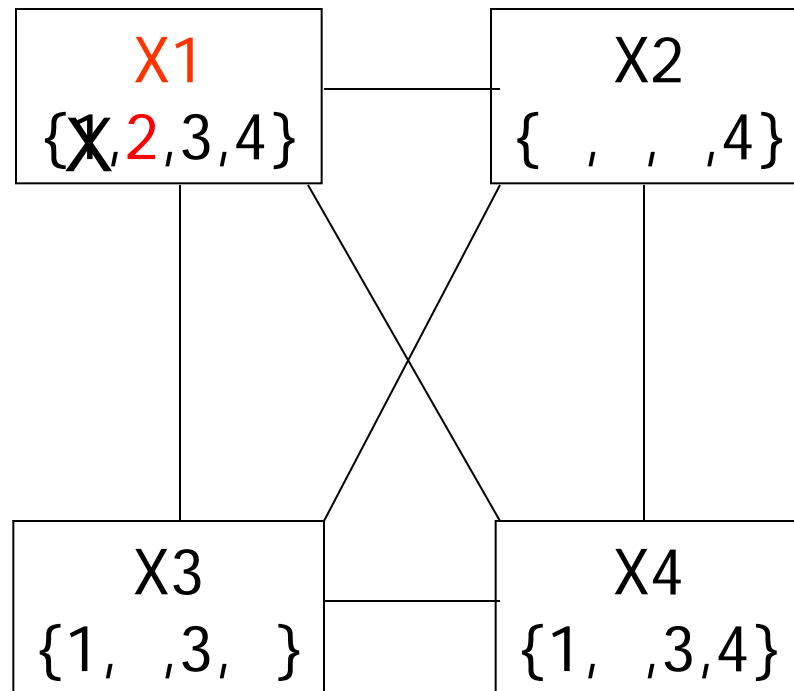
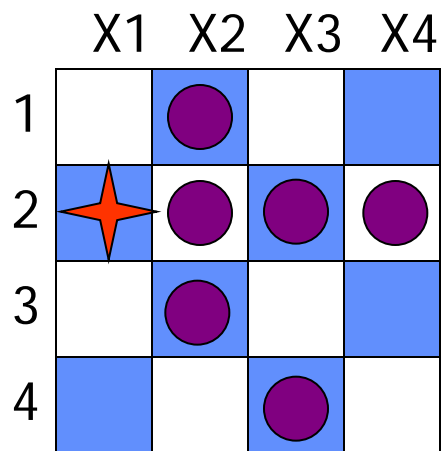

Red = value is assigned to variable

X = value led to failure

Example: 4-Queens Problem

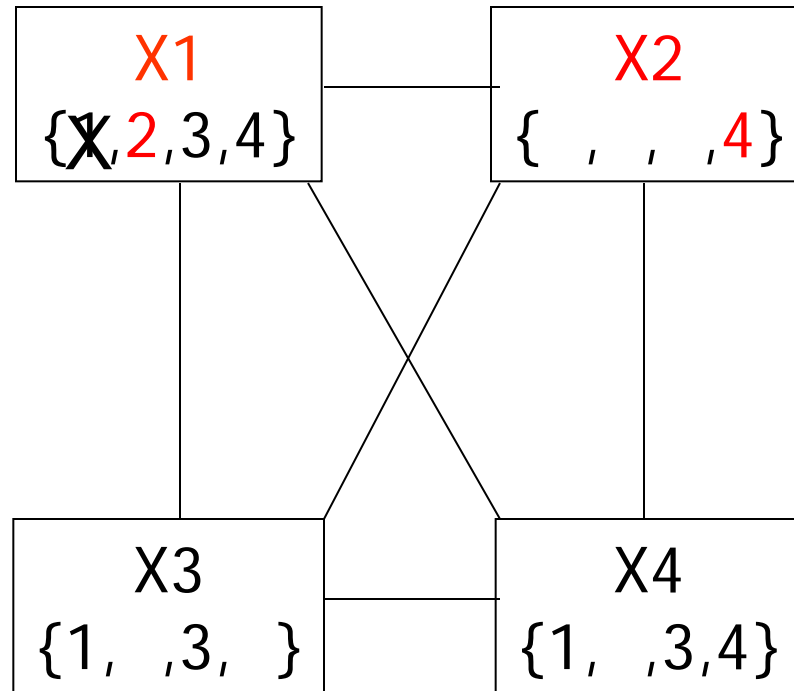
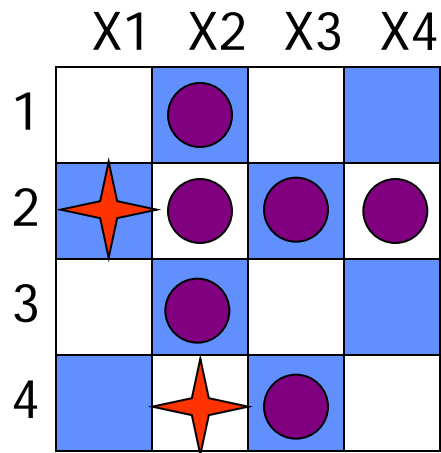

Red = value is assigned to variable

X = value led to failure

Example: 4-Queens Problem

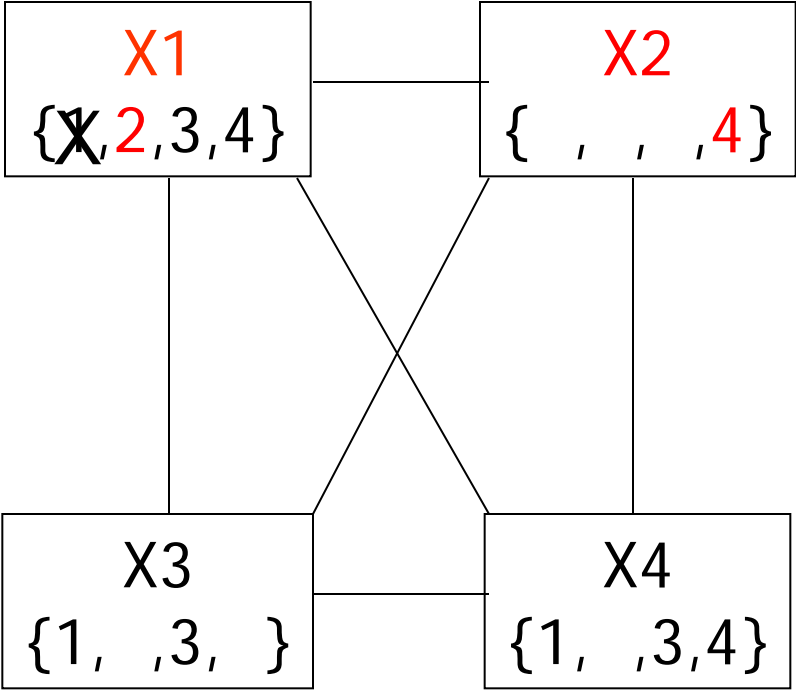
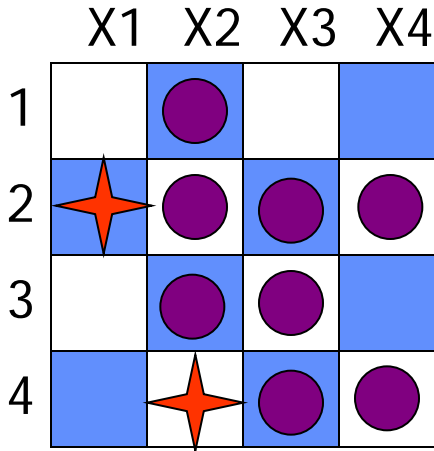

Red = value is assigned to variable
X = value led to failure

Example: 4-Queens Problem

- X1 Level:
 - Deleted:
 - { (X2,1) (X2,2) (X2,3) (X3,2) (X3,4) (X4,2) }
- X2 Level:
 - Deleted:
 - { (X3,3) (X4,4) }

Example: 4-Queens Problem

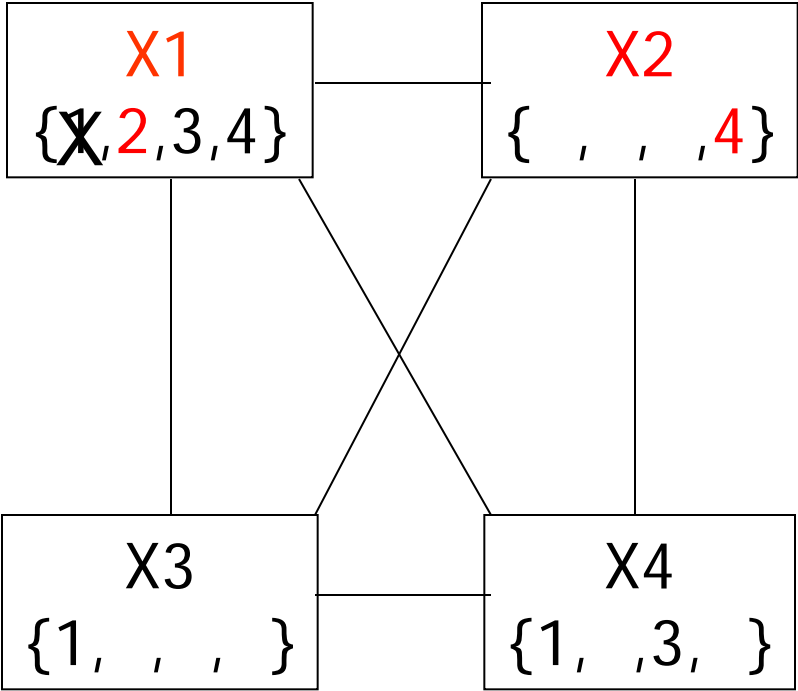
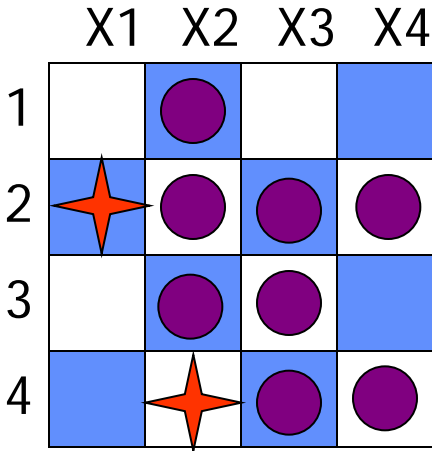

Red = value is assigned to variable
 X = value led to failure

Example: 4-Queens Problem

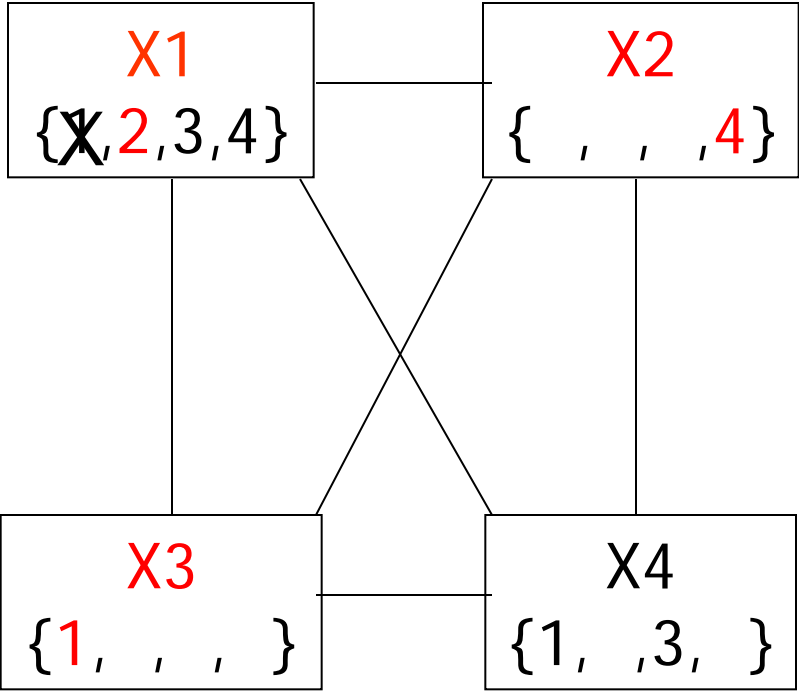
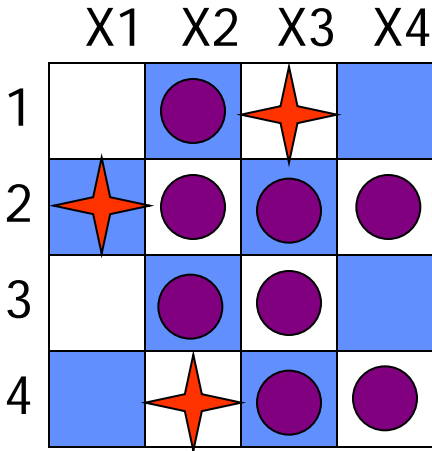

Red = value is assigned to variable
X = value led to failure

Example: 4-Queens Problem

	X1	X2	X3	X4
1		●	★	●
2	★	●	●	●
3		●	●	
4		★	●	●

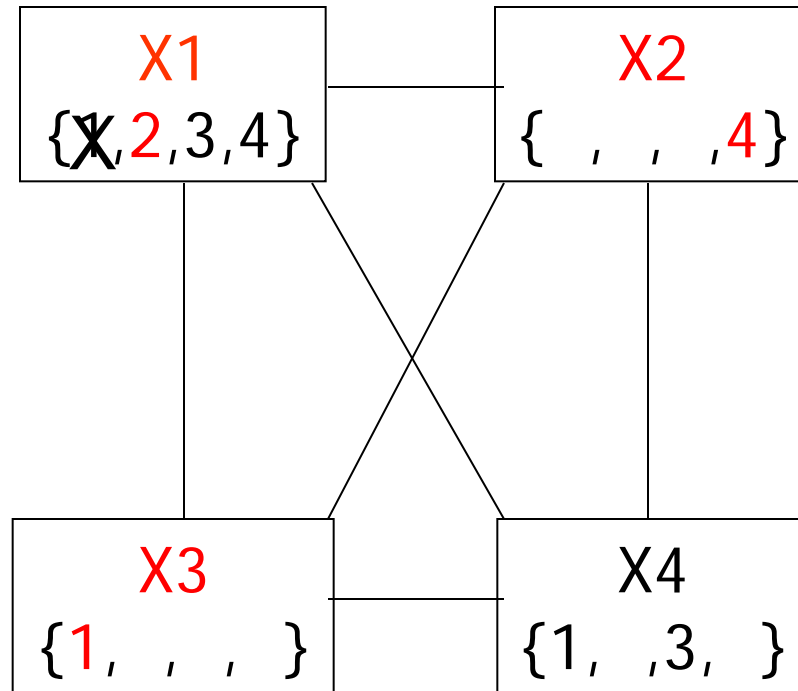

Red = value is assigned to variable
X = value led to failure

Example: 4-Queens Problem

- X1 Level:
 - Deleted:
 - { (X2,1) (X2,2) (X2,3) (X3,2) (X3,4) (X4,2) }
- X2 Level:
 - Deleted:
 - { (X3,3) (X4,4) }
- X3 Level:
 - Deleted:
 - { (X4,1) }

Example: 4-Queens Problem

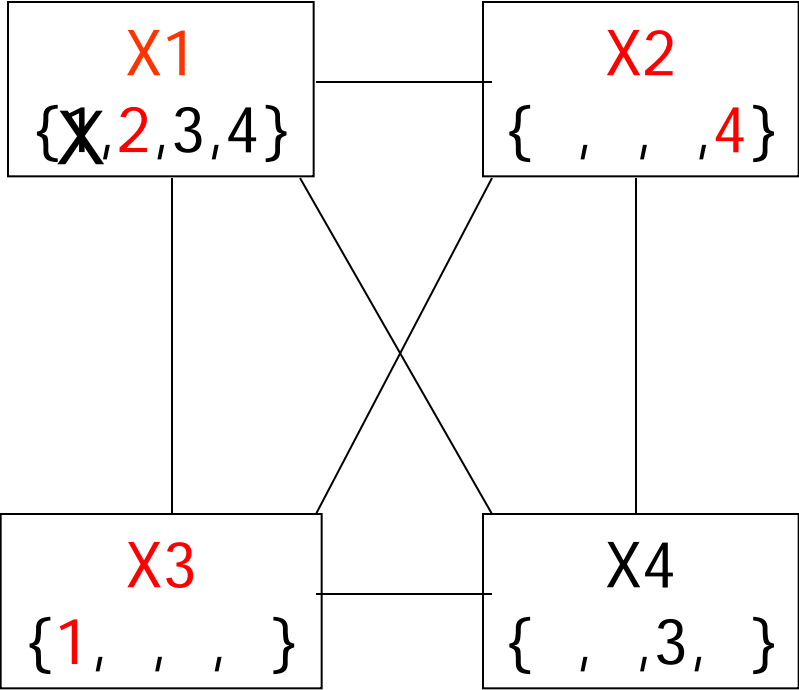
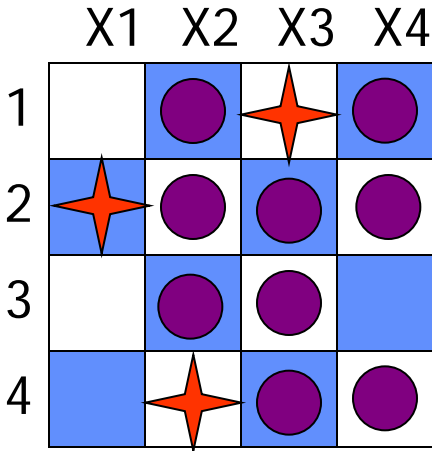

Red = value is assigned to variable
 X = value led to failure

Example: 4-Queens Problem

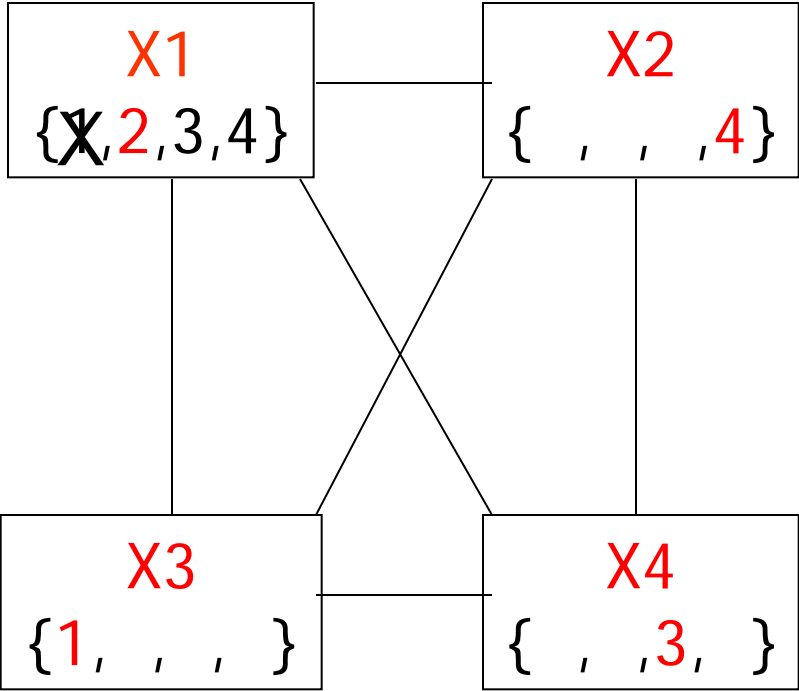
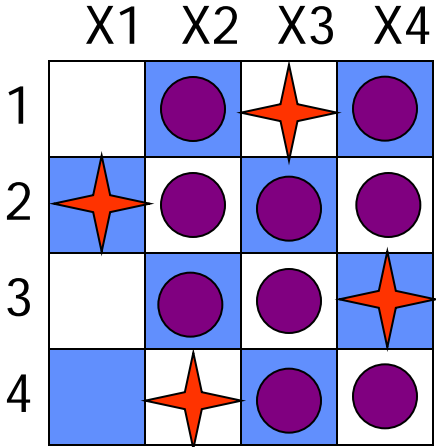

Red = value is assigned to variable
 X = value led to failure

Comparison of CSP algorithms on different problems

Problem	Backtracking	BT+MRV	Forward Checking	FC+MRV	Min-Conflicts
USA	(> 1,000K)	(> 1,000K)	2K	60	64
<i>n</i> -Queens	(> 40,000K)	13,500K	(> 40,000K)	817K	4K
Zebra	3,859K	1K	35K	0.5K	2K
Random 1	415K	3K	26K	2K	
Random 2	942K	27K	77K	15K	

Median number of consistency checks over 5 runs to solve problem

Parentheses -> no solution found

USA: 4 coloring

n-queens: $n = 2$ to 50

Zebra: see exercise 5.13

Constraint propagation

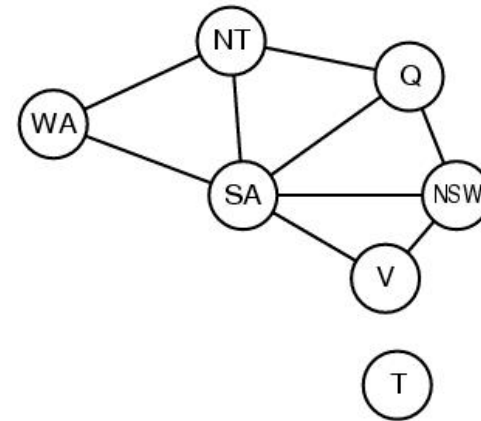
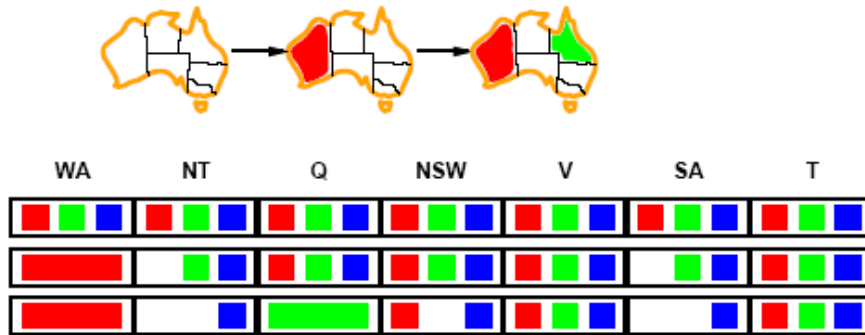

- Solving CSPs with combination of heuristics plus forward checking is more efficient than either approach alone
- FC checking does not detect all failures.
 - E.g., NT and SA cannot be blue

Constraint propagation

- Techniques like CP and FC are in effect eliminating parts of the search space
 - Somewhat complementary to search
- Constraint propagation goes further than FC by repeatedly enforcing constraints locally
 - Needs to be faster than actually searching to be effective
- Arc-consistency (AC) is a systematic procedure for constraint propagation

Arc consistency

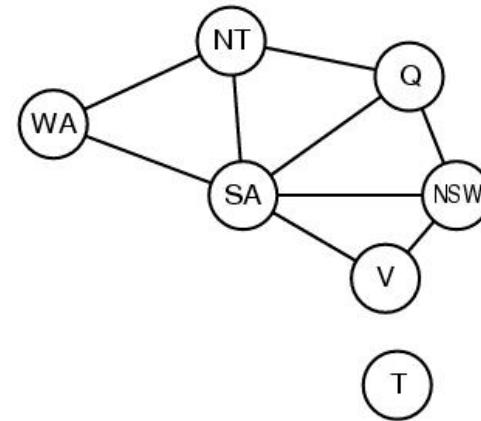
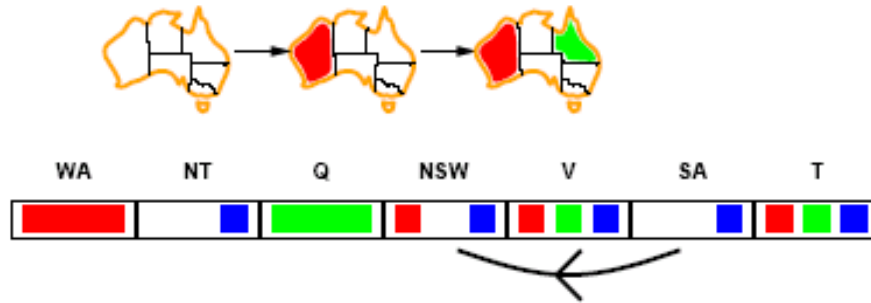

- An Arc $X \rightarrow Y$ is consistent if
for every value x of X there is some value y consistent with x
(note that this is a directed property)
- Consider state of search after WA and Q are assigned:
 $SA \rightarrow NSW$ is consistent if
 $SA=blue$ and $NSW=red$

Arc consistency

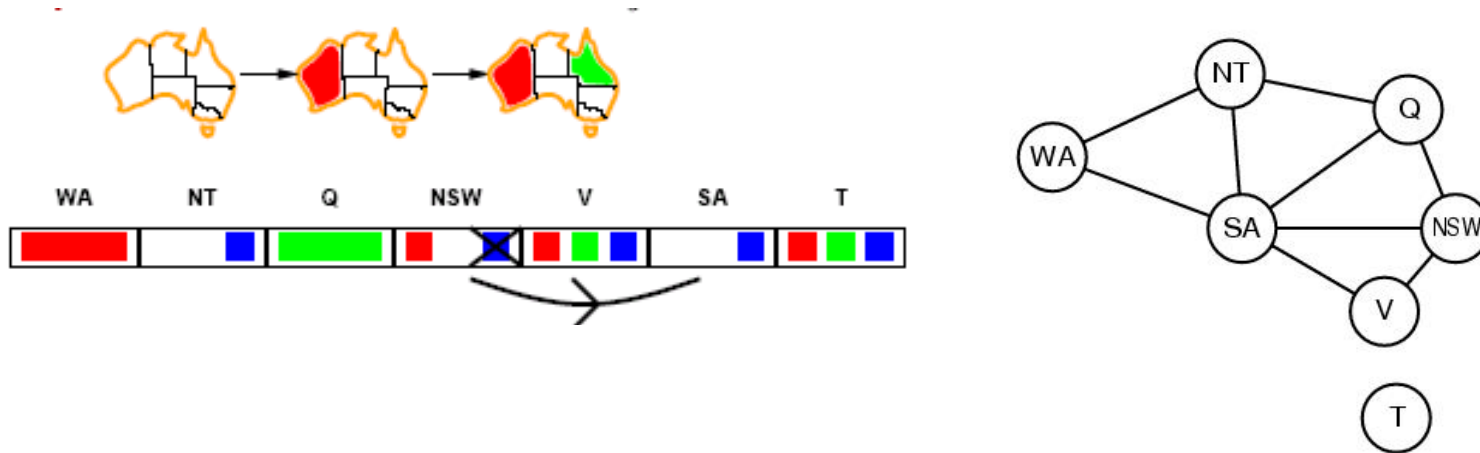

- $X \rightarrow Y$ is consistent if
for every value x of X there is some value y consistent with x
- $NSW \rightarrow SA$ is consistent if
 $NSW=red$ and $SA=blue$
 $NSW=blue$ and $SA=???$

Arc consistency

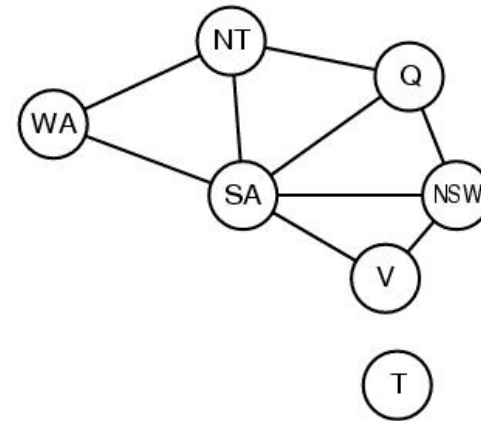
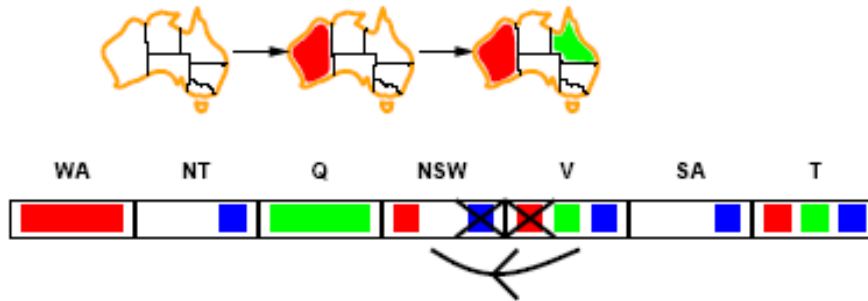

- Can enforce arc-consistency:
 - Arc can be made consistent by removing *blue* from *NSW*
- Continue to propagate constraints....
 - Check $V \rightarrow NSW$
 - Not consistent for $V = \text{red}$
 - Remove red from V

Arc consistency

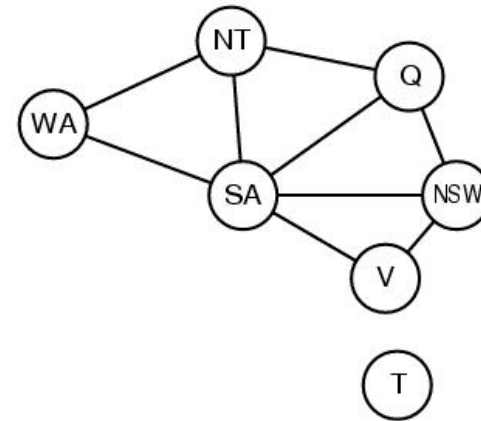
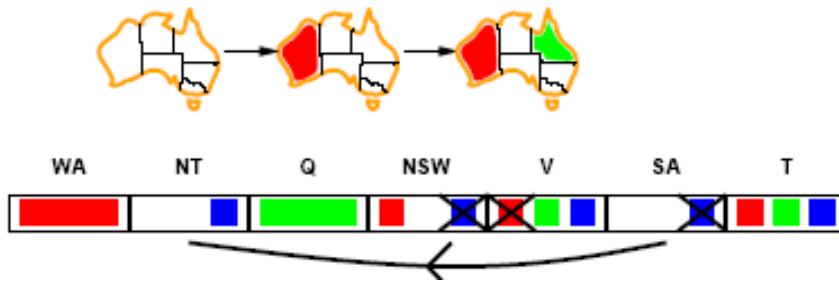

- Continue to propagate constraints....
- $SA \rightarrow NT$ is not consistent
 - and cannot be made consistent
- Arc consistency detects failure earlier than FC

Arc consistency checking

- Can be run as a preprocessor or after each assignment
 - Or as preprocessing before search starts
- AC must be run repeatedly until no inconsistency remains
- Trade-off
 - Requires some overhead to do, but generally more effective than direct search
 - In effect it can eliminate large (inconsistent) parts of the state space more effectively than search can
- Need a systematic method for arc-checking
 - If X loses a value, neighbors of X need to be rechecked:
i.e. incoming arcs can become inconsistent again
(outgoing arcs will stay consistent).

Arc consistency algorithm (AC-3)

function AC-3(*csp*) **returns** false if inconsistency found, else true, may reduce *csp* domains

inputs: *csp*, a binary CSP with variables $\{X_1, X_2, \dots, X_n\}$

local variables: *queue*, a queue of arcs, initially all the arcs in *csp*

/ initial queue must contain both (X_i, X_j) and (X_j, X_i) */*

while *queue* is not empty **do**

$(X_i, X_j) \leftarrow$ REMOVE-FIRST(*queue*)

if REMOVE-INCONSISTENT-VALUES(X_i, X_j) **then**

if size of $D_i = 0$ **then return** false

for each X_k **in** NEIGHBORS[X_i] – $\{X_j\}$ **do**

add (X_k, X_i) to *queue* if not already there

return true

function REMOVE-INCONSISTENT-VALUES(X_i, X_j) **returns** true iff we delete a value from the domain of X_i

removed \leftarrow false

for each x **in** DOMAIN[X_i] **do**

if no value y in DOMAIN[X_j] allows (x, y) to satisfy the constraints between X_i and X_j

then delete x from DOMAIN[X_i]; *removed* \leftarrow true

return *removed*

(from Mackworth, 1977)

Complexity of AC-3

- A binary CSP has at most n^2 arcs
- Each arc can be inserted in the queue d times (worst case)
 - (X, Y) : only d values of X to delete
- Consistency of an arc can be checked in $O(d^2)$ time
- Complexity is $O(n^2 d^3)$
- Although substantially more expensive than Forward Checking, Arc Consistency is usually worthwhile.

K-consistency

- Arc consistency does not detect all inconsistencies:
 - Partial assignment $\{WA=red, NSW=red\}$ is inconsistent.
- Stronger forms of propagation can be defined using the notion of k-consistency.
- A CSP is k-consistent if for any set of k-1 variables and for any consistent assignment to those variables, a consistent value can always be assigned to any kth variable.
 - E.g. 1-consistency = node-consistency
 - E.g. 2-consistency = arc-consistency
 - E.g. 3-consistency = path-consistency
- Strongly k-consistent:
 - k-consistent for all values $\{k, k-1, \dots, 2, 1\}$

Trade-offs

- Running stronger consistency checks...
 - Takes more time
 - But will reduce branching factor and detect more inconsistent partial assignments
 - No “free lunch”
 - In worst case n -consistency takes exponential time
- Generally helpful to enforce 2-Consistency (Arc Consistency)
- Sometimes helpful to enforce 3-Consistency
- Higher levels may take more time to enforce than they save.

Further improvements

- Checking special constraints
 - Checking Alldif(...) constraint
 - *E.g. {WA=red, NSW=red}*
 - Checking Atmost(...) constraint
 - *Bounds propagation for larger value domains*
- Intelligent backtracking
 - Standard form is chronological backtracking i.e. try different value for preceding variable.
 - More intelligent, backtrack to conflict set.
 - Set of variables that caused the failure or set of previously assigned variables that are connected to X by constraints.
 - Backjumping moves back to most recent element of the conflict set.
 - Forward checking can be used to determine conflict set.

Local search for CSPs

- Use complete-state representation
 - Initial state = all variables assigned values
 - Successor states = change 1 (or more) values
- For CSPs
 - allow states with unsatisfied constraints (unlike backtracking)
 - operators **reassign** variable values
 - hill-climbing with n-queens is an example
- Variable selection: randomly select any conflicted variable
- Value selection: *min-conflicts heuristic*
 - Select new value that results in a minimum number of conflicts with the other variables

Local search for CSP

function MIN-CONFLICTS(*csp*, *max_steps*) **return** solution or failure

inputs: *csp*, a constraint satisfaction problem

max_steps, the number of steps allowed before giving up

current ← an initial complete assignment for *csp*

for *i* = 1 to *max_steps* **do**

if *current* is a solution for *csp* then **return** *current*

var ← a randomly chosen, conflicted variable from VARIABLES[*csp*]

value ← the value *v* for *var* that minimize CONFLICTS(*var*, *v*, *current*, *csp*)

 set *var* = *value* in *current*

return *failure*

Min-conflicts example 1

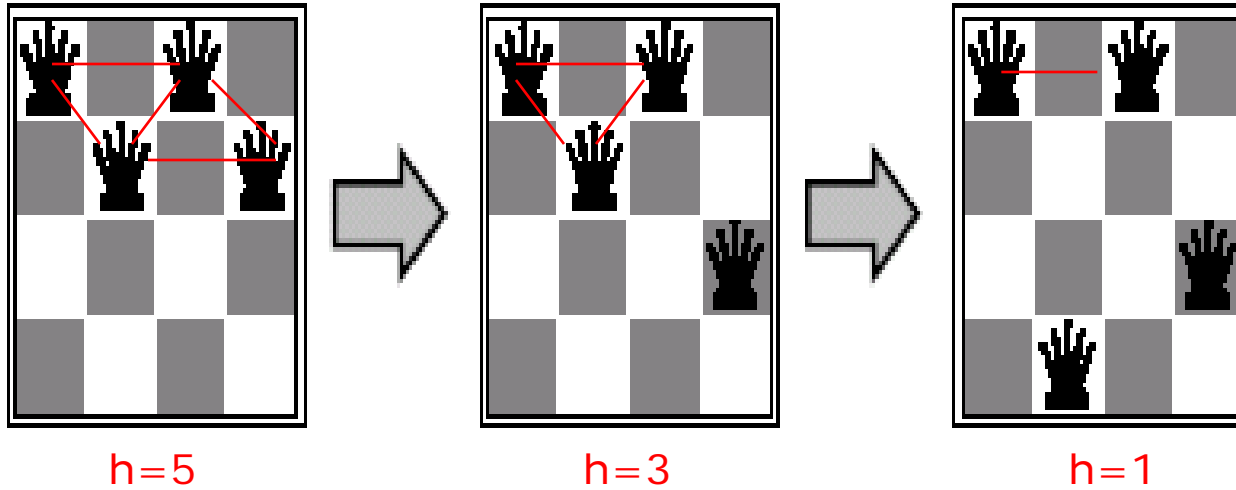

Use of min-conflicts heuristic in hill-climbing.

Min-conflicts example 2

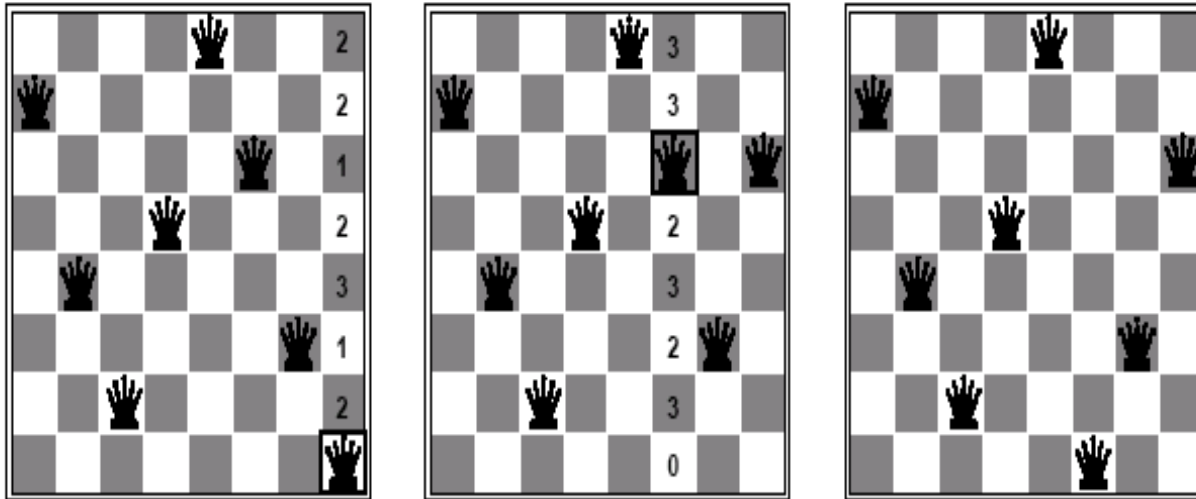

- A two-step solution for an 8-queens problem using min-conflicts heuristic
- At each stage a queen is chosen for reassignment in its column
- The algorithm moves the queen to the min-conflict square breaking ties randomly.

Comparison of CSP algorithms on different problems

Problem	Backtracking	BT+MRV	Forward Checking	FC+MRV	Min-Conflicts
USA	(> 1,000K)	(> 1,000K)	2K	60	64
<i>n</i> -Queens	(> 40,000K)	13,500K	(> 40,000K)	817K	4K
Zebra	3,859K	1K	35K	0.5K	2K
Random 1	415K	3K	26K	2K	
Random 2	942K	27K	77K	15K	

Median number of consistency checks over 5 runs to solve problem

Parentheses -> no solution found

USA: 4 coloring

n-queens: $n = 2$ to 50

Zebra: see exercise 6.7 (3rd ed.); exercise 5.13 (2nd ed.)

Advantages of local search

- Local search can be particularly useful in an online setting
 - Airline schedule example
 - E.g., mechanical problems require than 1 plane is taken out of service
 - Can locally search for another “close” solution in state-space
 - Much better (and faster) in practice than finding an entirely new schedule
- The runtime of min-conflicts is roughly independent of problem size.
 - Can solve the millions-queen problem in roughly 50 steps.
 - Why?
 - n-queens is easy for local search because of the relatively high density of solutions in state-space

Performance of min-conflicts

Given random initial state, can solve n -queens in almost constant time for arbitrary n with high probability (e.g., $n = 10,000,000$)

The same appears to be true for any randomly-generated CSP **except** in a narrow range of the ratio

$$R = \frac{\text{number of constraints}}{\text{number of variables}}$$

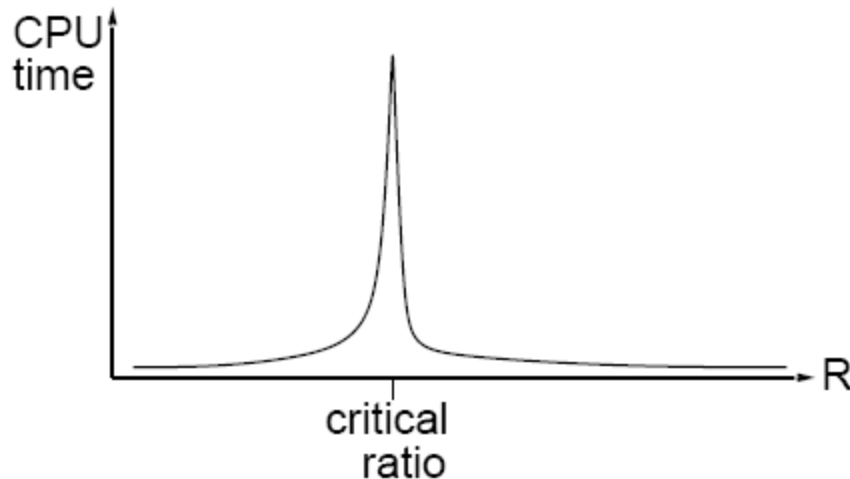

Hard satisfiability problems

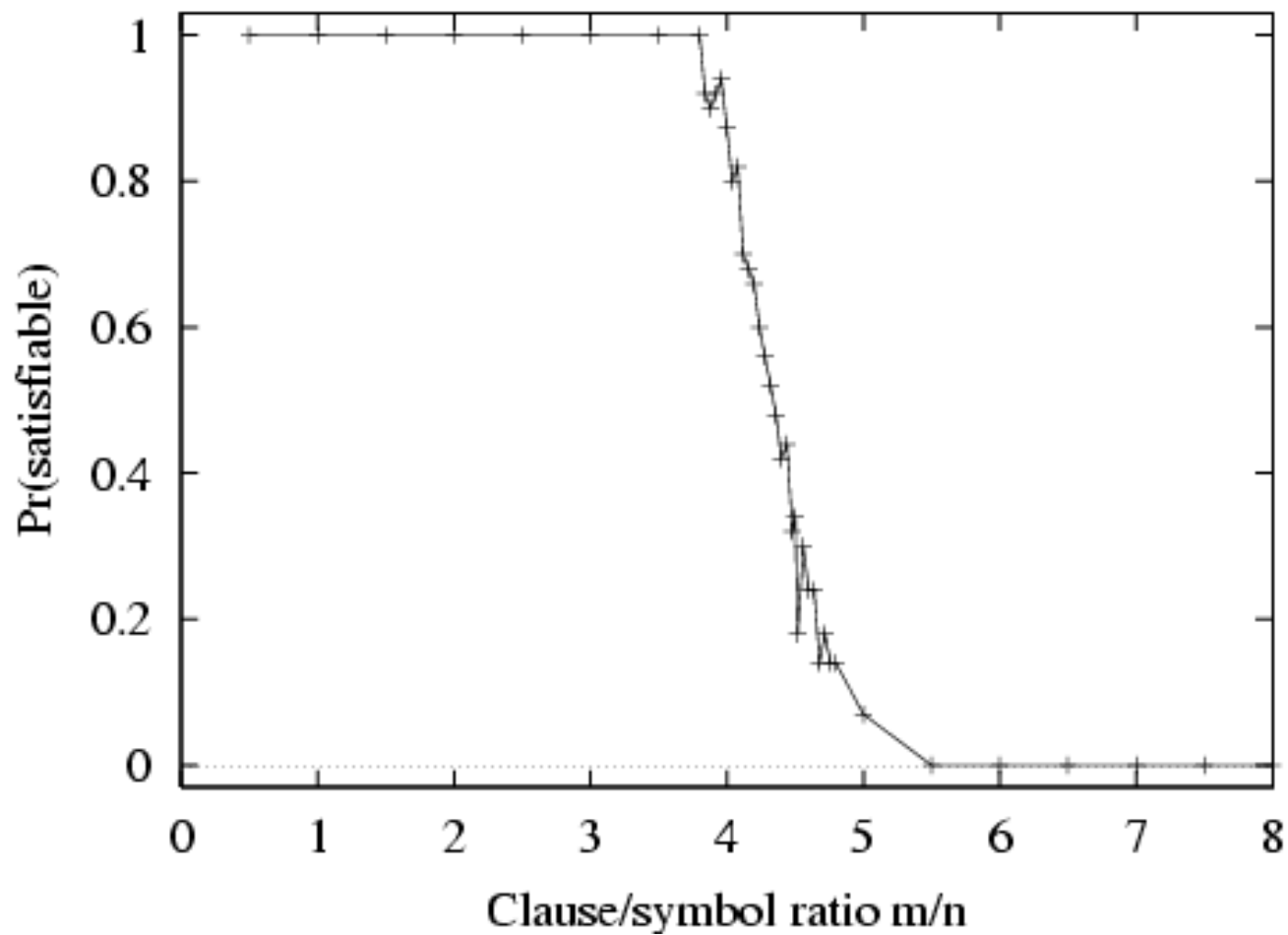

Hard satisfiability problems

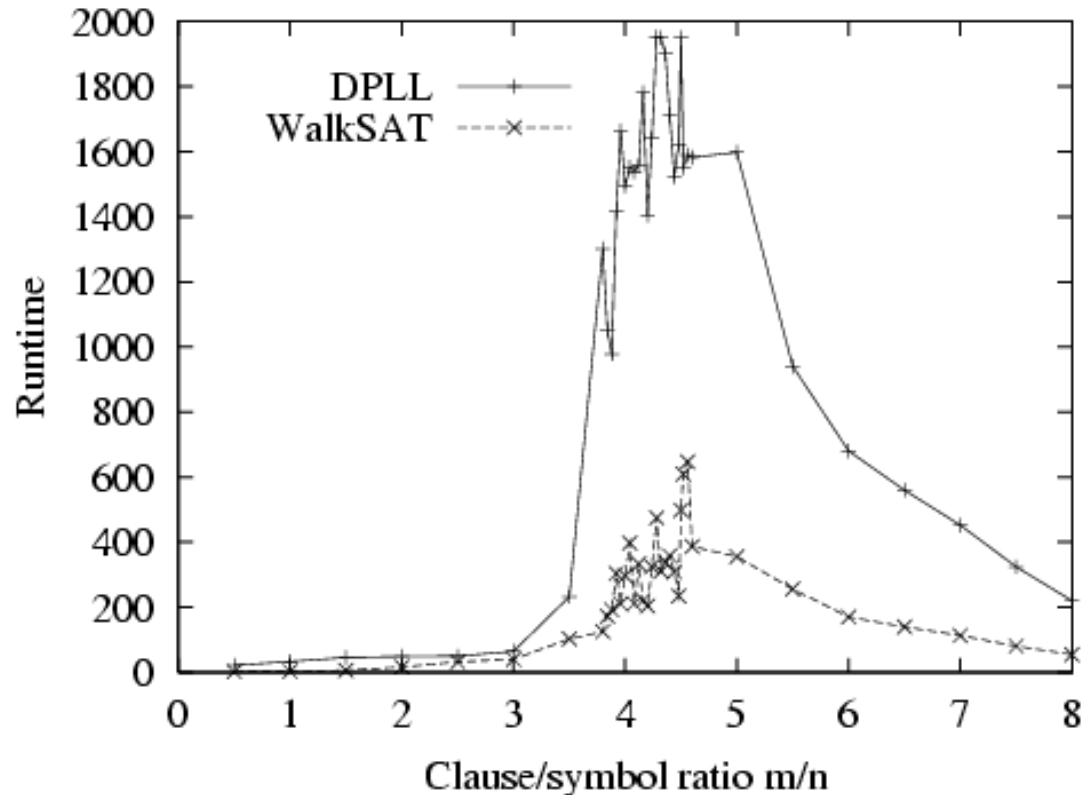

- Median runtime for 100 **satisfiable** random 3-CNF sentences, $n = 50$

Sudoku — Backtracking Search + Forward Checking

Avg Time vs. R

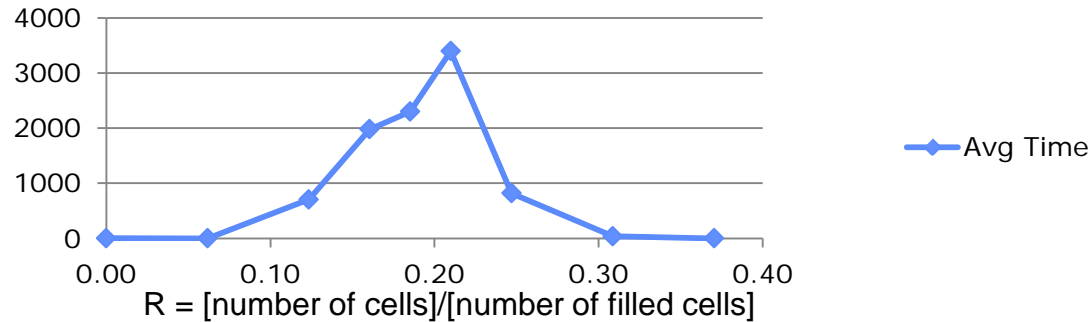

Success Rate vs. R

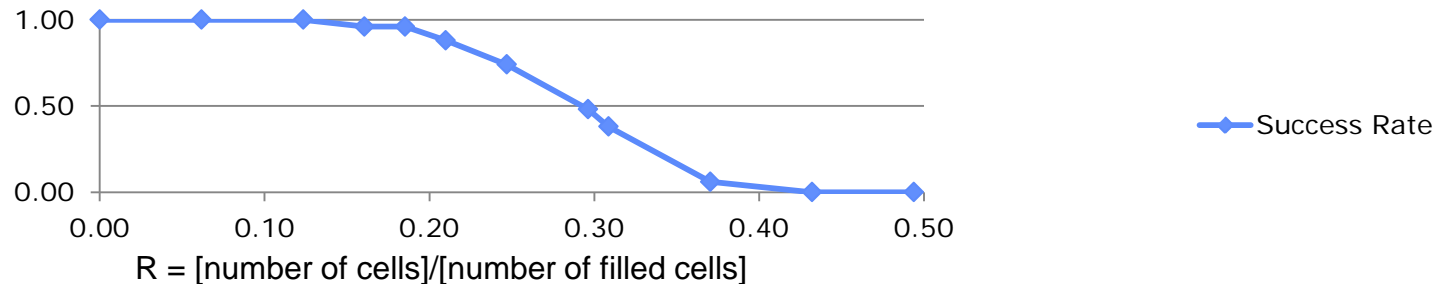

- $R = [\text{number of cells}]/[\text{number of filled cells}]$
- Success Rate = $P(\text{random puzzle is solvable})$
- [number of cells] = 81
- [number of filled cells] = variable

Graph structure and problem complexity

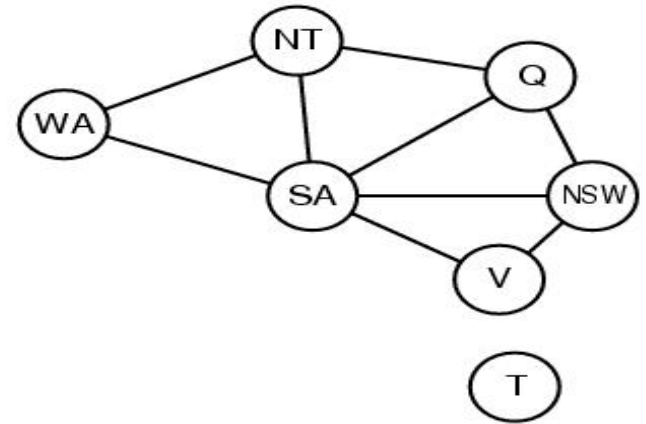

- Solving disconnected subproblems
 - Suppose each subproblem has c variables out of a total of n .
 - Worst case solution cost is $O(n/c d^c)$, i.e. linear in n
 - Instead of $O(d^n)$, exponential in n
- E.g. $n=80, c=20, d=2$
 - $2^{80} = 4$ billion years at 1 million nodes/sec.
 - $4 * 2^{20} = .4$ second at 1 million nodes/sec

Tree-structured CSPs

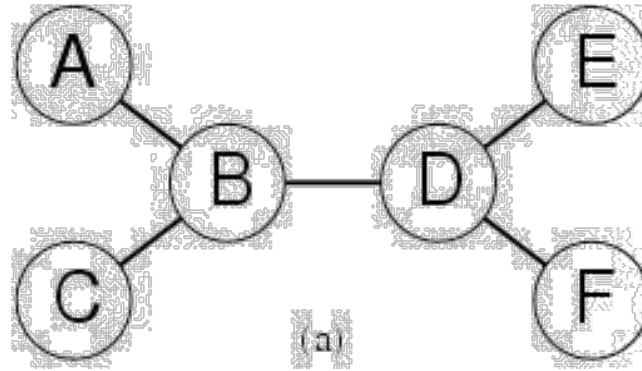

- Theorem:
 - if a constraint graph has no loops then the CSP can be solved in $O(nd^2)$ time
 - linear in the number of variables!
- Compare difference with general CSP, where worst case is $O(d^n)$

Summary

- CSPs
 - special kind of problem: states defined by values of a fixed set of variables, goal test defined by constraints on variable values
- Backtracking=depth-first search with one variable assigned per node
- Heuristics
 - Variable ordering and value selection heuristics help significantly
- Constraint propagation does additional work to constrain values and detect inconsistencies
 - Works effectively when combined with heuristics
- Iterative min-conflicts is often effective in practice.
- Graph structure of CSPs determines problem complexity
 - e.g., tree structured CSPs can be solved in linear time.