

# Introduction to Artificial Intelligence

CS171, Fall Quarter, 2019  
Introduction to Artificial Intelligence  
Prof. Richard Lathrop

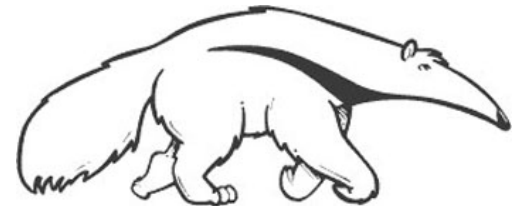

**Read Beforehand: R&N 1-2, 26.preamble, 26.3-4, 27.4**  
**Optional: R&N 26.1-2, 27.1-3**

# What is AI?

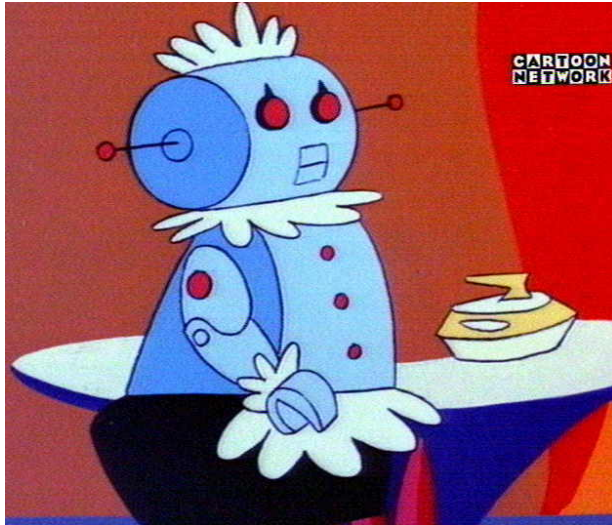

?  
=



?  
=



# What is AI?

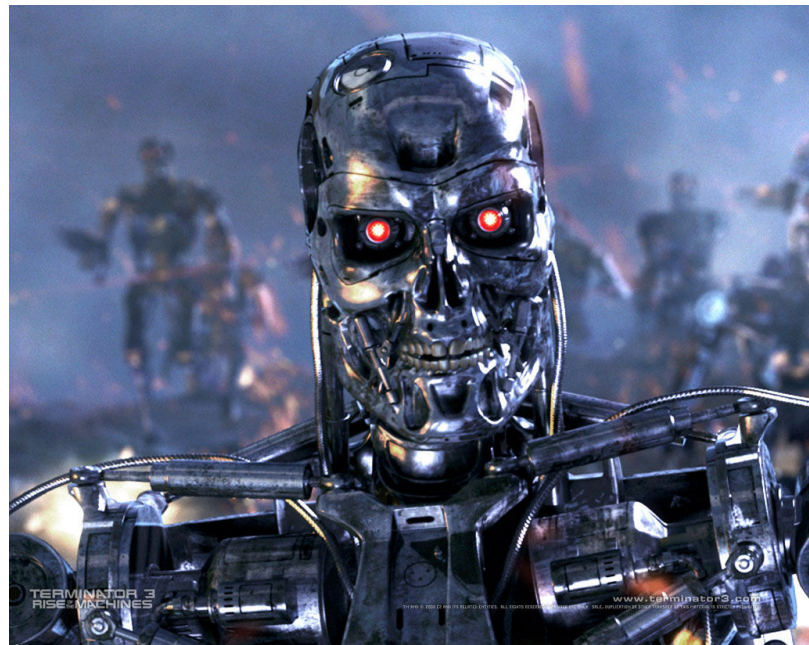
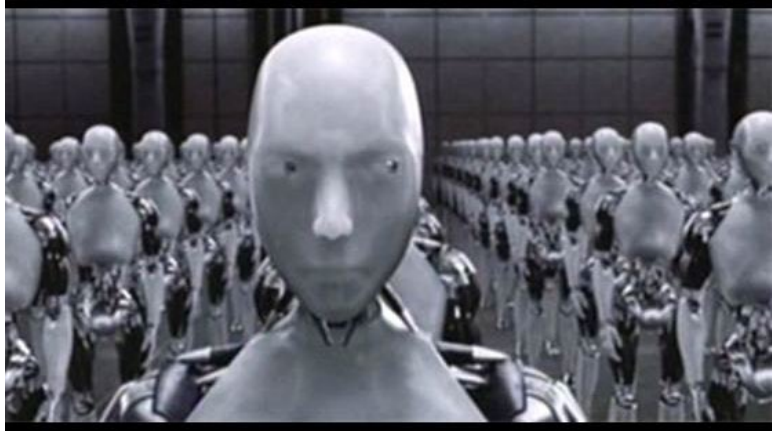

# What is Artificial Intelligence

([John McCarthy](#), Basic Questions)

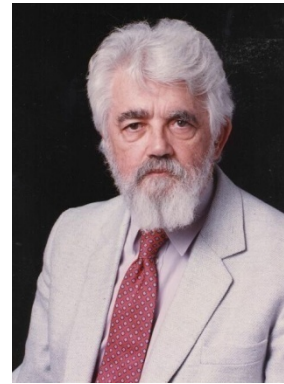

- **What is artificial intelligence?**
- It is the science and engineering of making intelligent machines, especially intelligent computer programs. It is related to the similar task of using computers to understand human intelligence, but AI does not have to confine itself to methods that are biologically observable.
- **Yes, but what is intelligence?**
- Intelligence is the computational part of the ability to achieve goals in the world. Varying kinds and degrees of intelligence occur in people, many animals and some machines.
- **Isn't there a solid definition of intelligence that doesn't depend on relating it to human intelligence?**
- Not yet. The problem is that we cannot yet characterize in general what kinds of computational procedures we want to call intelligent. We understand some of the mechanisms of intelligence and not others.
- More in: <http://www-formal.stanford.edu/jmc/whatisai/node1.html>

# The Turing test

[Can Machine think? A. M. Turing, 1950](#)

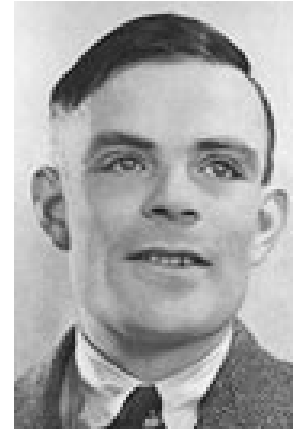

- Test requires computer to “pass itself off” as human

- Necessary?
- Sufficient?

- Requires:

- Natural language
- Knowledge representation
- Automated reasoning
- Machine learning
- (vision, robotics) for full test

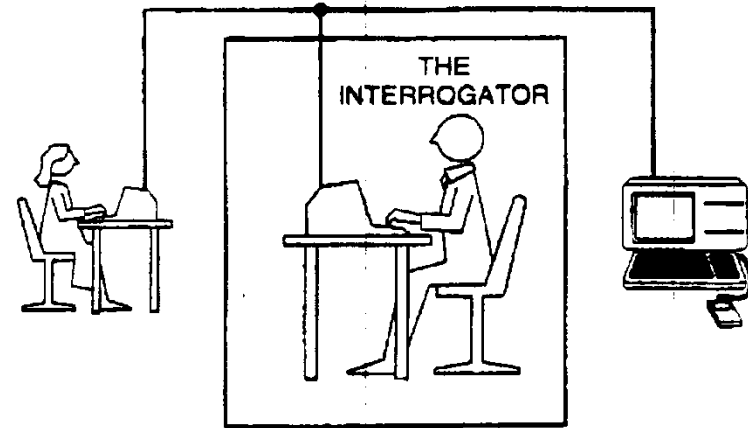

**Figure 1.1** The Turing test.

# What is Artificial Intelligence?

- Nils J. Nilsson :
  - “Artificial intelligence is that activity devoted to making machines intelligent, and intelligence is that quality that enables an entity to function appropriately and with foresight in its environment.”

# What is Artificial Intelligence?

- **Thought processes**
  - “The exciting new effort to make computers **think** .. Machines with minds, in the full and literal sense” (Haugeland, 1985)
- **Behavior**
  - “The study of how to make computers **do things** at which, at the moment, people are better.” (Rich, and Knight, 1991)
- **Activities**
  - The automation of activities that we associate with human thinking, activities such as decision-making, problem solving, learning... (Bellman)
- **Things we would call “intelligent” if done by a human**



# AI as “Raisin Bread”



- Esther Dyson [predicted] AI would [be] embedded in main-stream, strategically important systems, like raisins in a loaf of raisin bread.
  - The “bread” represents any main-stream computer-augmented engineering system.
  - The “raisins” represent nuggets of control, where “smart” control  $\Rightarrow$  better function.
- Time has proven Dyson's prediction correct.
- Emphasis shifts away from replacing expensive human experts toward main-stream computing systems that create strategic advantage.
- Many AI systems connect to large data bases, deal with legacy data, talk to networks, handle noise and data corruption, are implemented in popular languages, and run on standard operating systems.
- Humans usually are important contributors to the total solution.
  - Adapted from Patrick Winston, former Director, MIT AI Laboratory



# What is AI?

- Competing axes of definitions:
  - Thinking vs. Acting
  - Human-like vs. Rational
  - Often not the same thing
  - Cognitive science, economics, ...
- How to simulate human intellect & behavior by machine
  - Mathematical problems (puzzles, games, theorems)
  - Common-sense reasoning
  - Expert knowledge (law, medicine)
  - Social behavior
  - Web & online intelligence
  - Planning, e.g. operations research

# Act/Think Humanly/Rationally

- Act Humanly
  - Turing test
- Think Humanly
  - Introspection; Cognitive science
- Think rationally
  - Logic; representing & reasoning over problems
- Acting rationally
  - Agents; sensing & acting; feedback systems

# Current “Hot” areas/applications

- Big Data/knowledge extraction with Machine Learning
  - BD2K = “Big Data to Knowledge”
- Deep Learning/artificial neural systems
- Transportation/logistics/self-driving cars
- Robotics/factory automation/mobility for the disabled
- Vision/scene or video analysis
- Internet/social media
- Biology/medicine/improving healthcare
- Question answering/knowledge retrieval
- Finance/market trading/personal wealth management
- Your favorite area here....

# Agents

- An **agent** is anything that can be viewed as **perceiving** its **environment** through **sensors** and **acting** upon that environment through **actuators**
- Human agent:
  - Sensors: eyes, ears, ...
  - Actuators: hands, legs, mouth...
- Robotic agent
  - Sensors: cameras, range finders, ...
  - Actuators: motors



# Agents

- **Craik (1943; R&N p. 13) specified the three key steps of a knowledge-based agent:**
  - (1) the stimulus must be translated into an internal representation;
  - (2) the representation is manipulated by cognitive processes to derive new internal representations;
  - and (3) these representations are in turn retranslated back into action.

# Agents and environments

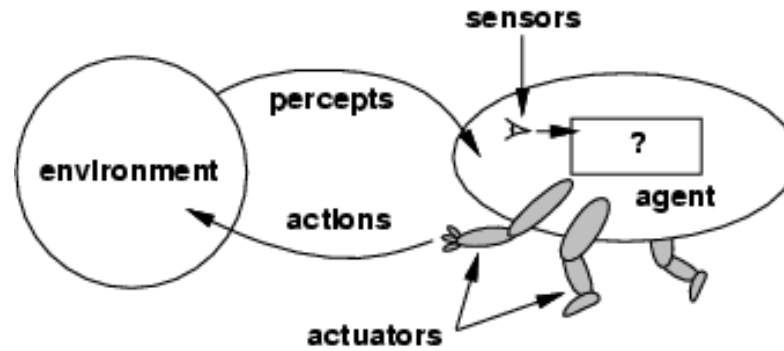

## Compare: Standard Embedded System Structure

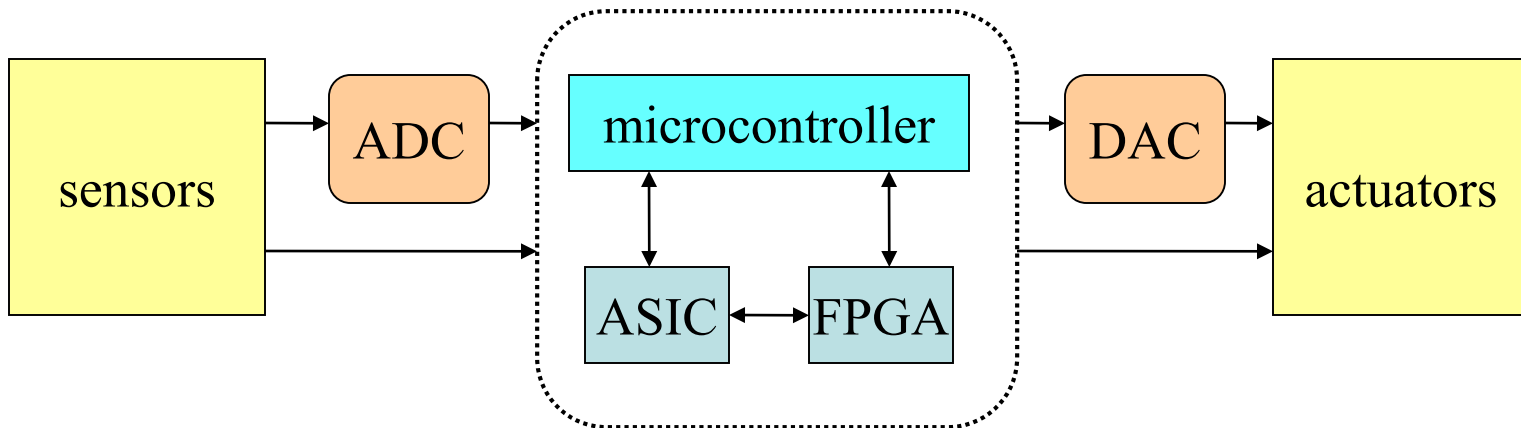

# Agents and environments

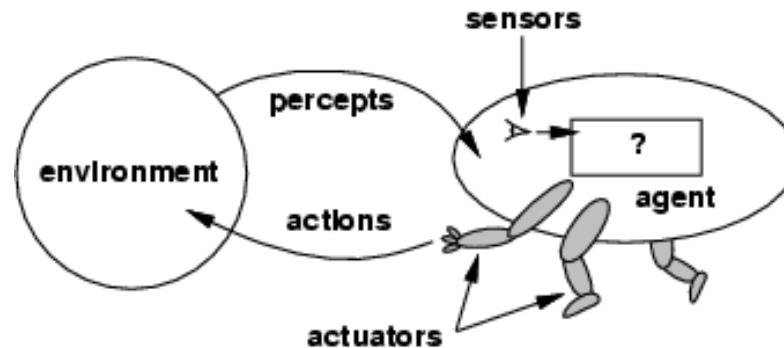

- The **agent function** maps from percept histories to actions:

$$[f: P^* \rightarrow \mathcal{A}]$$

- The **agent program** runs on the physical **architecture** to produce  $f$
- agent = architecture + program

# Vacuum World

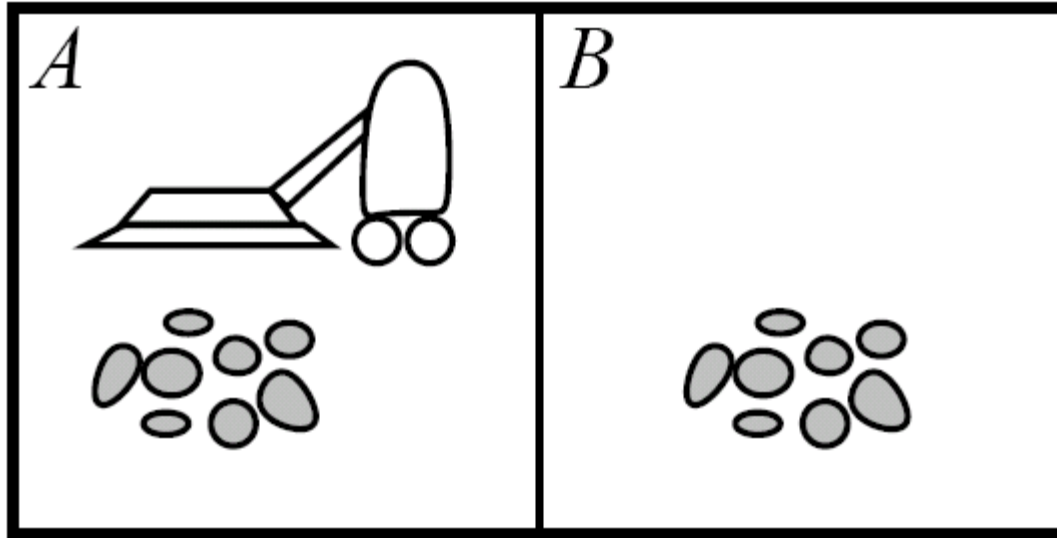

- **Percepts:** location, contents
  - e.g., [A, dirty]
- **Actions:** {left, right, vacuum,...}



# Rational agents

- **Rational Agent:** For each possible percept sequence, a rational agent should select an action that is *expected* to maximize its **performance measure**, based on the evidence provided by the percept sequence and whatever built-in knowledge the agent has.
- **Performance measure:** An objective criterion for success of an agent's behavior (“cost”, “reward”, “utility”)
- **E.g.,** performance measure of a vacuum-cleaner agent could be amount of dirt cleaned up, amount of time taken, amount of electricity consumed, amount of noise generated, etc.

# Rational agents

- **Rationality** is **distinct** from **omniscience** (all-knowing with infinite knowledge)
- Agents can perform actions in order to modify future percepts so as to obtain useful information (**information gathering, exploration**)
- An agent is **autonomous** if its behavior is determined by its own percepts & experience (with ability to **learn and adapt**) without depending solely on build-in knowledge

# Task environment

- To design a rational agent, we must specify the task environment — **“PEAS”**
- Example: automated taxi system
  - Performance measure
    - Safety, destination, profits, legality, comfort, ...
  - Environment
    - City streets, freeways; traffic, pedestrians, weather, ...
  - Actuators
    - Steering, brakes, accelerator, horn, ...
  - Sensors
    - Video, sonar, radar, GPS / navigation, keyboard, ...

# PEAS

- Example: Agent = Medical diagnosis system

**Performance measure:** Healthy patient, minimize costs, lawsuits

**Environment:** Patient, hospital, staff

**Actuators:** Screen display (questions, tests, diagnoses, treatments, referrals)

**Sensors:** Keyboard (entry of symptoms, findings, patient's answers)

# PEAS

- Example: Agent = Part-picking robot (a robot that picks up parts or tools and places them in a new location)
- **Performance measure:** Percentage of parts in correct bins
- **Environment:** Conveyor belt with parts, bins
- **Actuators:** Jointed arm and hand
- **Sensors:** Camera, joint angle sensors

# Environment types

- **Fully observable** (vs. **partially observable**): An agent's sensors give it access to the complete state of the environment at each point in time.
- **Deterministic** (vs. **stochastic**): The next state of the environment is completely determined by the current state and the action executed by the agent. (If the environment is deterministic except for the actions of other agents, then the environment is **strategic**.)
- **Episodic** (vs. **sequential**): An agent's action is divided into atomic episodes. Decisions do not depend on previous decisions/actions.
- **Known** (vs. **unknown**): An environment is considered to be "known" if the agent understands the laws that govern the environment's behavior.

# Environment types

- **Static (vs. dynamic)**: The environment is unchanged while an agent is deliberating. (The environment is **semidynamic** if the environment itself does not change with the passage of time but the agent's performance score does)
- **Discrete (vs. continuous)**: A limited number of distinct, clearly defined percepts and actions.
  - How do we **represent** or **abstract** or **model** the world?
- **Single agent (vs. multi-agent)**: An agent operating by itself in an environment. Does the other agent interfere with my performance measure?

<b>task environm.</b>	<b>observable</b>	<b>determ./ stochastic</b>	<b>episodic/ sequential</b>	<b>static/ dynamic</b>	<b>discrete/ continuous</b>	<b>agents</b>
<b>crossword puzzle</b>	<b>fully</b>	<b>determ.</b>	<b>sequential</b>	<b>static</b>	<b>discrete</b>	<b>single</b>
<b>chess with clock</b>	<b>fully</b>	<b>strategic</b>	<b>sequential</b>	<b>semi</b>	<b>discrete</b>	<b>multi</b>
<b>poker</b>						
<b>back gammon</b>						
<b>taxi driving</b>	<b>partial</b>	<b>stochastic</b>	<b>sequential</b>	<b>dynamic</b>	<b>continuous</b>	<b>multi</b>
<b>medical diagnosis</b>	<b>partial</b>	<b>stochastic</b>	<b>sequential</b>	<b>dynamic</b>	<b>continuous</b>	<b>single</b>
<b>image analysis</b>	<b>fully</b>	<b>determ.</b>	<b>episodic</b>	<b>semi</b>	<b>continuous</b>	<b>single</b>
<b>partpicking robot</b>	<b>partial</b>	<b>stochastic</b>	<b>episodic</b>	<b>dynamic</b>	<b>continuous</b>	<b>single</b>
<b>refinery controller</b>	<b>partial</b>	<b>stochastic</b>	<b>sequential</b>	<b>dynamic</b>	<b>continuous</b>	<b>single</b>
<b>interact. Eng. tutor</b>	<b>partial</b>	<b>stochastic</b>	<b>sequential</b>	<b>dynamic</b>	<b>discrete</b>	<b>multi</b>



<b>task environm.</b>	<b>observable</b>	<b>determ./ stochastic</b>	<b>episodic/ sequential</b>	<b>static/ dynamic</b>	<b>discrete/ continuous</b>	<b>agents</b>
<b>crossword puzzle</b>	<b>fully</b>	<b>determ.</b>	<b>sequential</b>	<b>static</b>	<b>discrete</b>	<b>single</b>
<b>chess with clock</b>	<b>fully</b>	<b>strategic</b>	<b>sequential</b>	<b>semi</b>	<b>discrete</b>	<b>multi</b>
<b>poker</b>	<b>partial</b>	<b>stochastic</b>	<b>sequential</b>	<b>static</b>	<b>discrete</b>	<b>multi</b>
<b>back gammon</b>						
<b>taxi driving</b>	<b>partial</b>	<b>stochastic</b>	<b>sequential</b>	<b>dynamic</b>	<b>continuous</b>	<b>multi</b>
<b>medical diagnosis</b>	<b>partial</b>	<b>stochastic</b>	<b>sequential</b>	<b>dynamic</b>	<b>continuous</b>	<b>single</b>
<b>image analysis</b>	<b>fully</b>	<b>determ.</b>	<b>episodic</b>	<b>semi</b>	<b>continuous</b>	<b>single</b>
<b>partpicking robot</b>	<b>partial</b>	<b>stochastic</b>	<b>episodic</b>	<b>dynamic</b>	<b>continuous</b>	<b>single</b>
<b>refinery controller</b>	<b>partial</b>	<b>stochastic</b>	<b>sequential</b>	<b>dynamic</b>	<b>continuous</b>	<b>single</b>
<b>interact. Eng. tutor</b>	<b>partial</b>	<b>stochastic</b>	<b>sequential</b>	<b>dynamic</b>	<b>discrete</b>	<b>multi</b>

<b>task environm.</b>	<b>observable</b>	<b>determ./ stochastic</b>	<b>episodic/ sequential</b>	<b>static/ dynamic</b>	<b>discrete/ continuous</b>	<b>agents</b>
<b>crossword puzzle</b>	<b>fully</b>	<b>determ.</b>	<b>sequential</b>	<b>static</b>	<b>discrete</b>	<b>single</b>
<b>chess with clock</b>	<b>fully</b>	<b>strategic</b>	<b>sequential</b>	<b>semi</b>	<b>discrete</b>	<b>multi</b>
<b>poker</b>	<b>partial</b>	<b>stochastic</b>	<b>sequential</b>	<b>static</b>	<b>discrete</b>	<b>multi</b>
<b>back gammon</b>	<b>fully</b>	<b>stochastic</b>	<b>sequential</b>	<b>static</b>	<b>discrete</b>	<b>multi</b>
<b>taxi driving</b>	<b>partial</b>	<b>stochastic</b>	<b>sequential</b>	<b>dynamic</b>	<b>continuous</b>	<b>multi</b>
<b>medical diagnosis</b>	<b>partial</b>	<b>stochastic</b>	<b>sequential</b>	<b>dynamic</b>	<b>continuous</b>	<b>single</b>
<b>image analysis</b>	<b>fully</b>	<b>determ.</b>	<b>episodic</b>	<b>semi</b>	<b>continuous</b>	<b>single</b>
<b>partpicking robot</b>	<b>partial</b>	<b>stochastic</b>	<b>episodic</b>	<b>dynamic</b>	<b>continuous</b>	<b>single</b>
<b>refinery controller</b>	<b>partial</b>	<b>stochastic</b>	<b>sequential</b>	<b>dynamic</b>	<b>continuous</b>	<b>single</b>
<b>interact. Eng. tutor</b>	<b>partial</b>	<b>stochastic</b>	<b>sequential</b>	<b>dynamic</b>	<b>discrete</b>	<b>multi</b>

# Agent types

Six basic types, in order of increasing generality:

- Table Driven agents
- Simple reflex agents
- Model-based reflex agents
- Goal-based agents
- Utility-based agents
- Learning agents

# Table Driven Agent.

current state of decision process

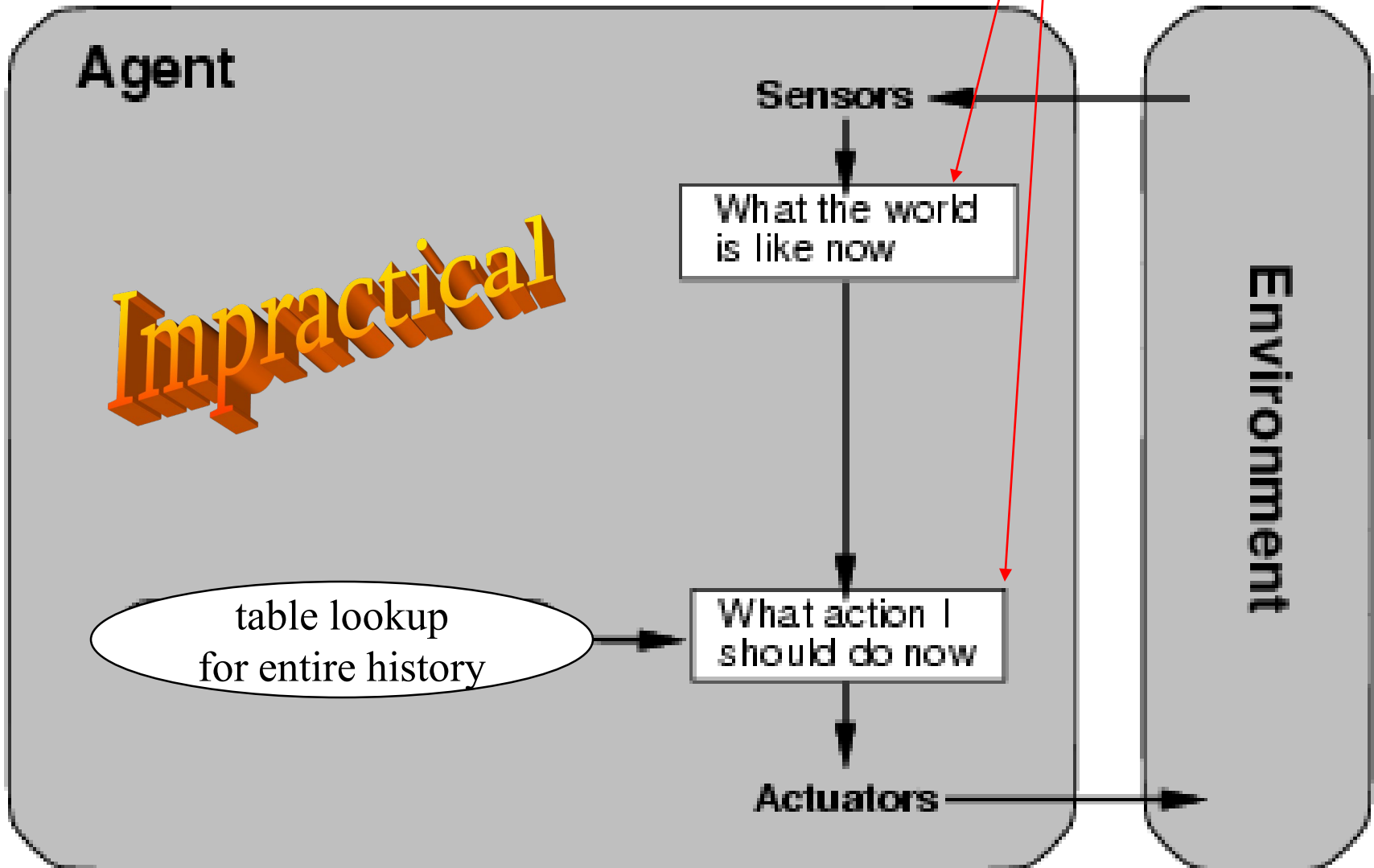

# Simple reflex agents

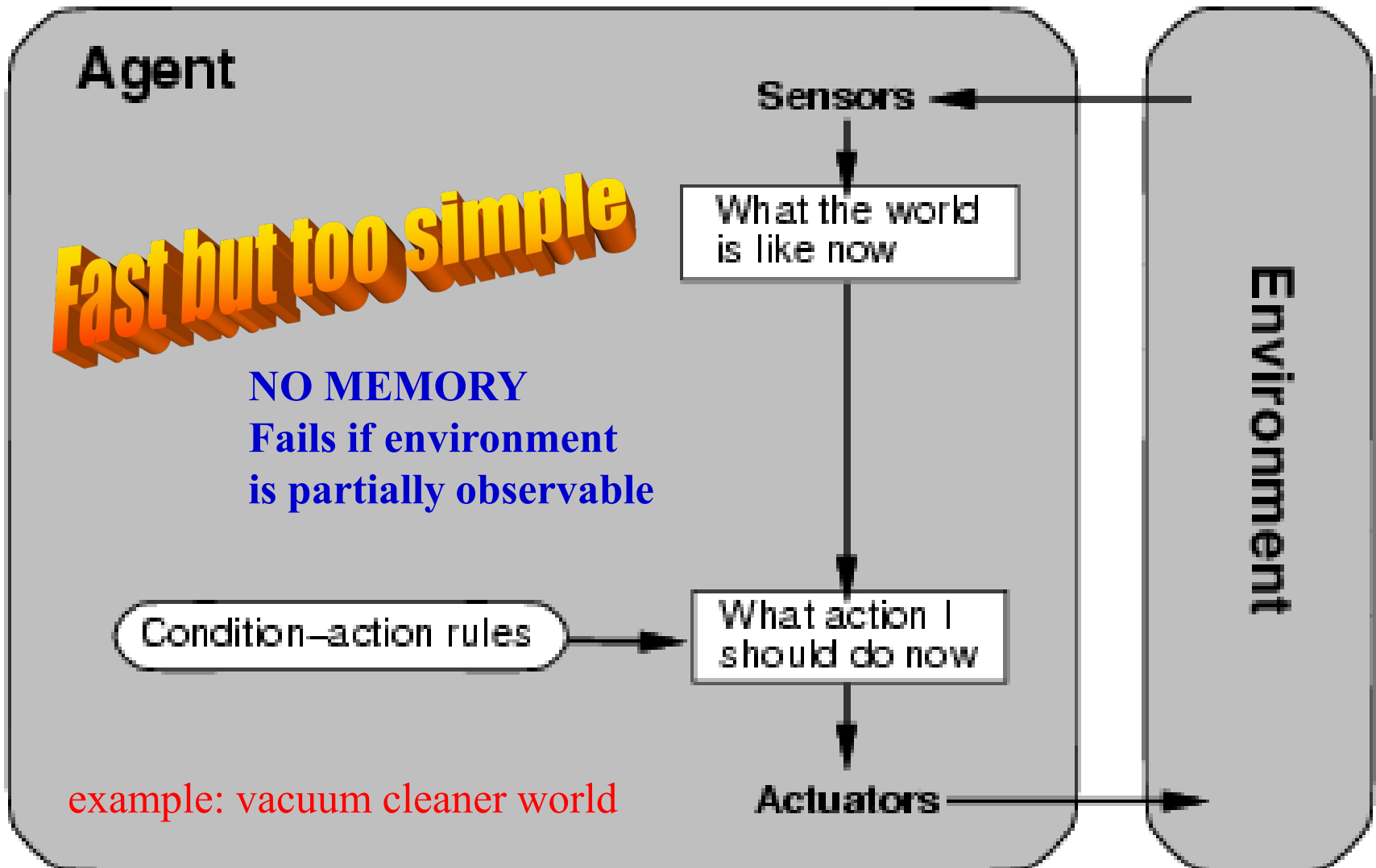

# Model-based reflex agents

description of  
current world state

Model the state of the world by:  
modeling how the world changes  
how its actions change the world

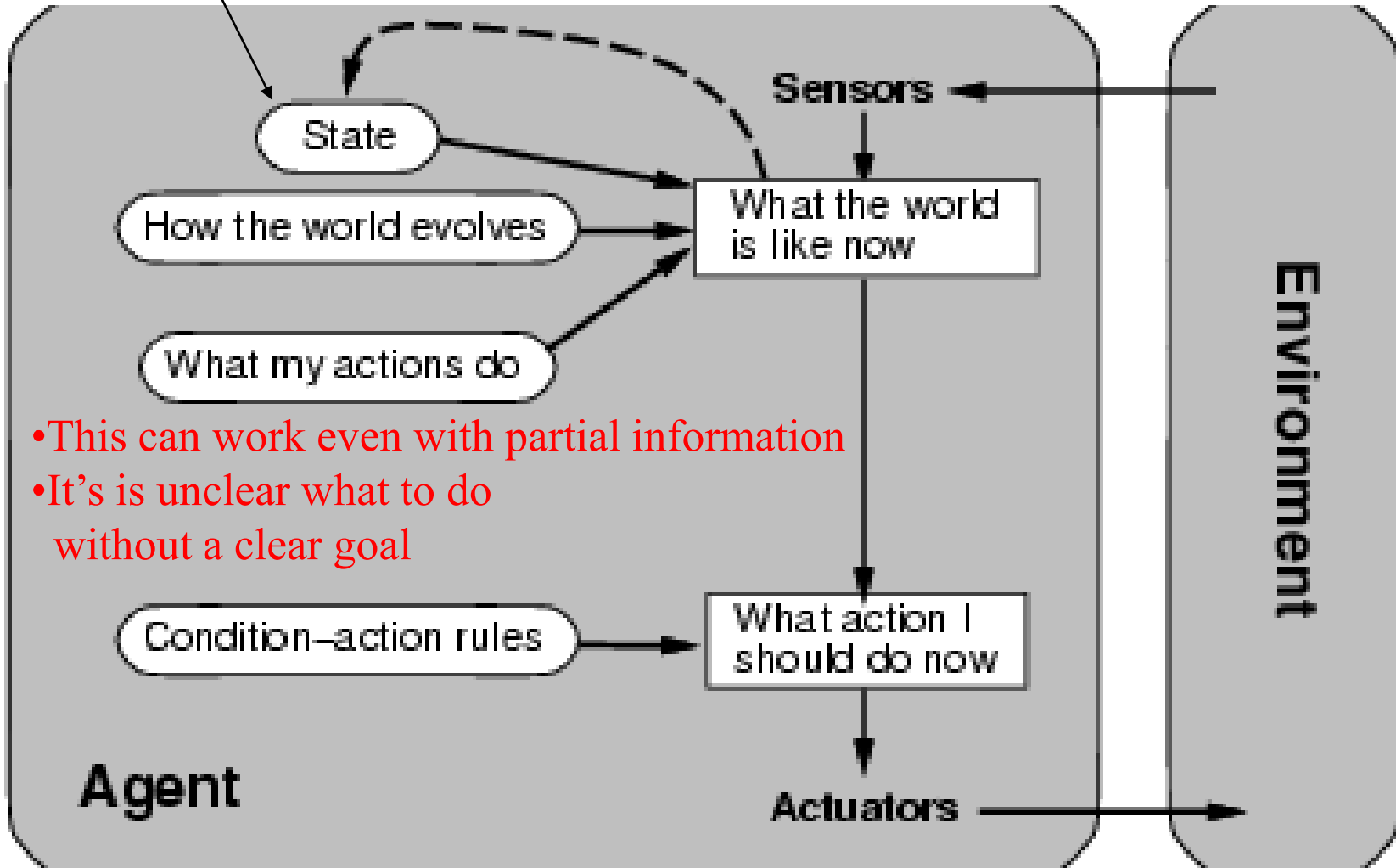

# Goal-based agents

Goals provide reason to prefer one action over the other.  
We need to predict the future: we need to plan & search

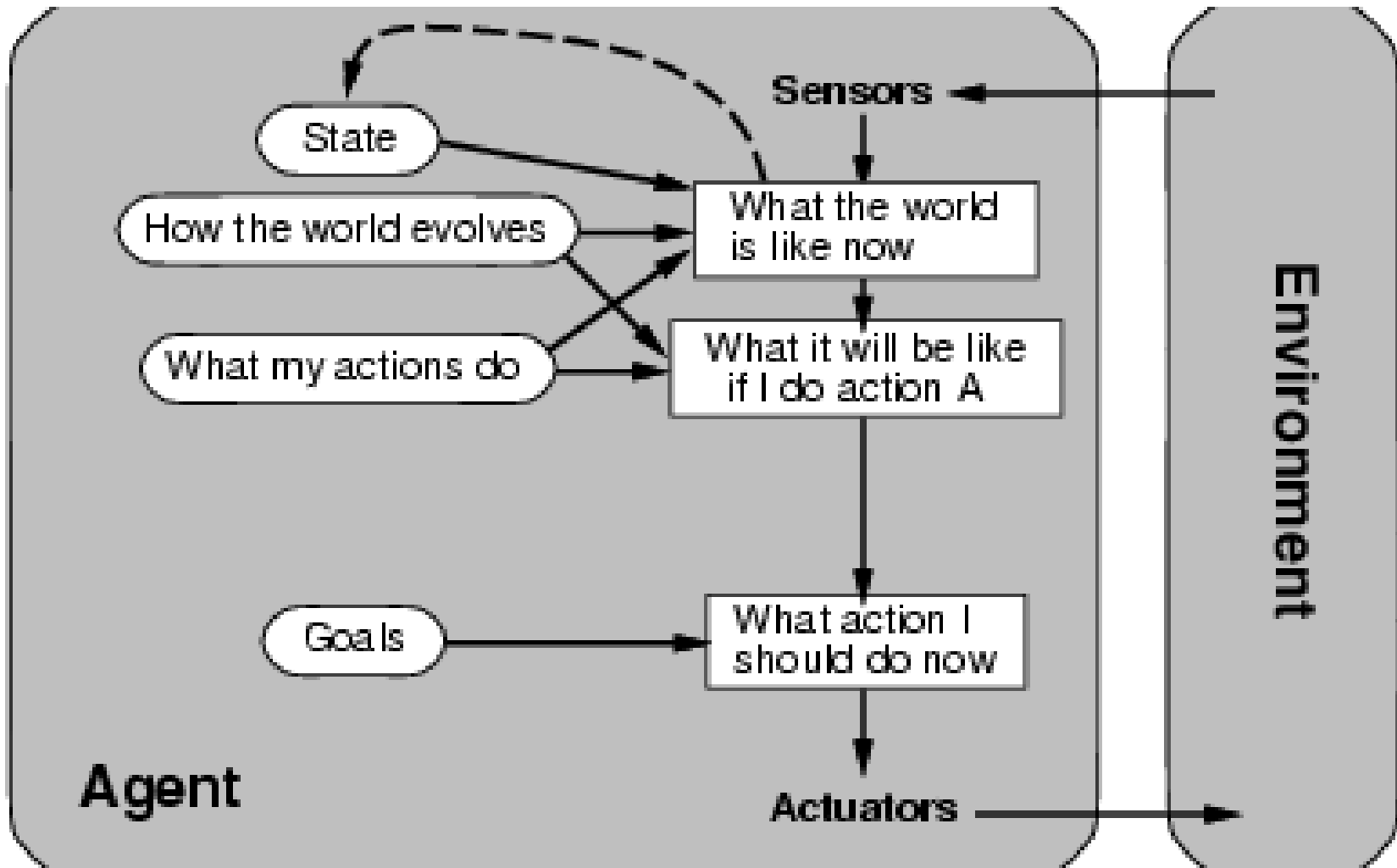

# Utility-based agents

Some solutions to goal states are better than others.  
Which one is best is given by a utility function.  
Which combination of goals is preferred?

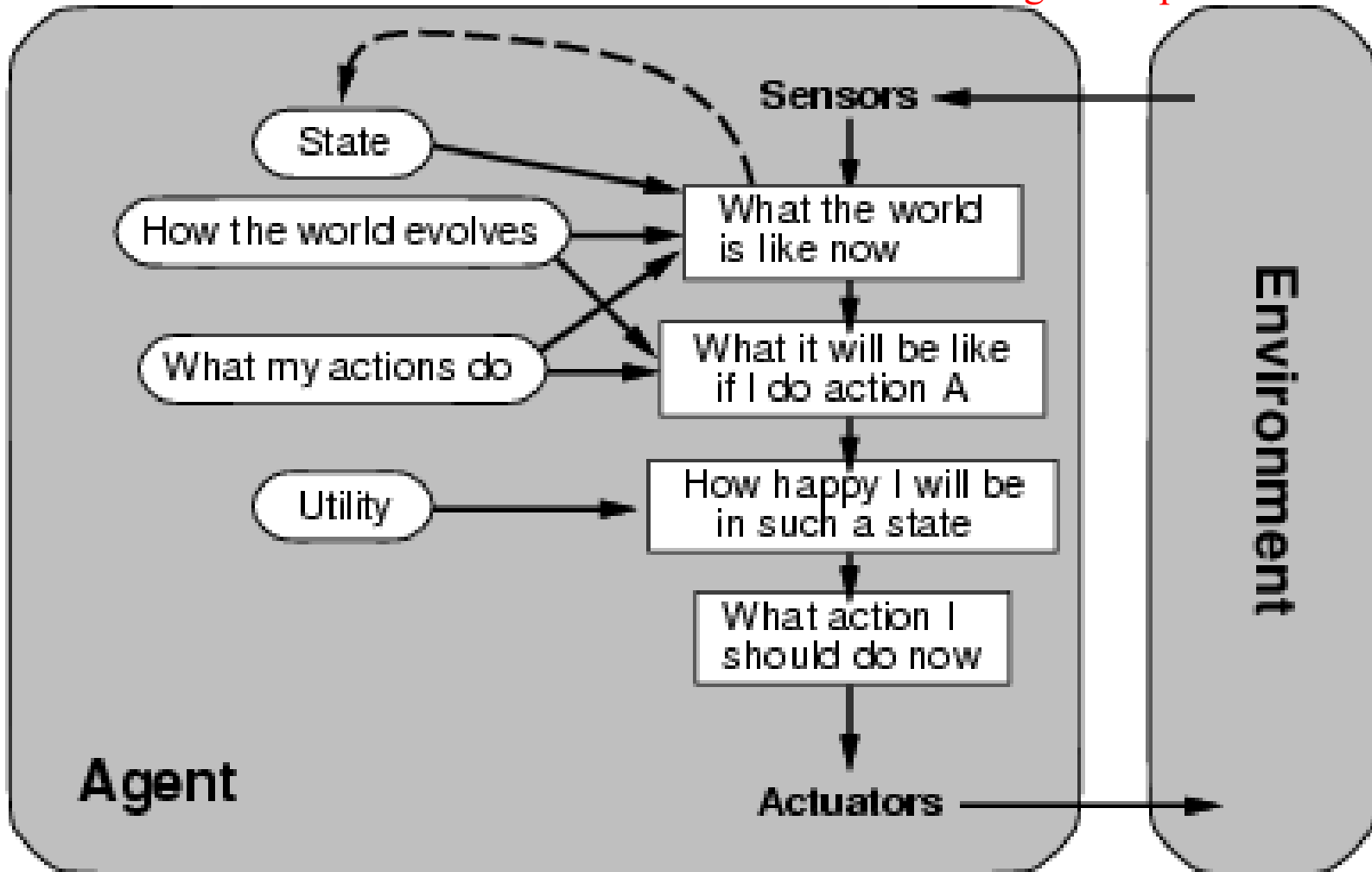



# Learning agents

How does an agent improve over time?

By monitoring it's performance and suggesting better modeling, new action rules, etc.

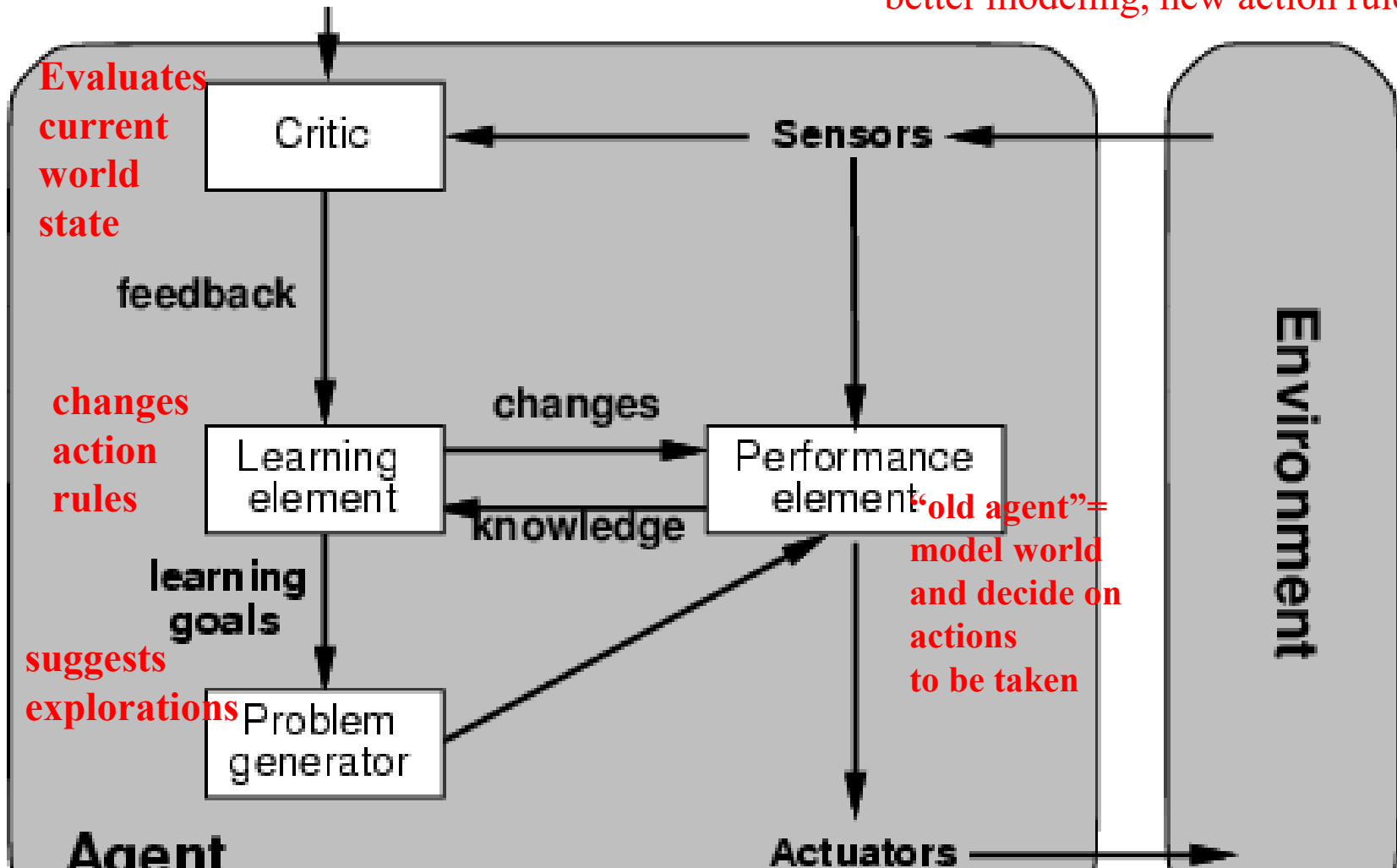

# AI Foundations and Philosophy

## Weak AI vs. Strong AI Hypotheses

- **Weak AI hypothesis:**
  - Machines could act *as if* they were intelligent
- **Strong AI hypothesis:**
  - Machines that do so are *actually* thinking (not just *simulating* thinking)
- **My personal view:** This question is really about linguistics and how you define “thinking,” not about technology.
- “Most AI researchers take the weak AI hypothesis for granted, and don’t care about the strong AI hypothesis — as long as their program works, they don’t care whether you call it a simulation of intelligence or real intelligence. All AI researchers should be concerned with the ethical implications of their work.” — R&N p. 1020

# AI Foundations and Philosophy

## The Technological “Singularity”

- “Let an **ultraintelligent machine** be defined as a machine that can far surpass all the intellectual activities of any man however clever. Since the design of machines is one of these intellectual activities, an ultraintelligent machine could design even better machines; there would then unquestionably be an ‘intelligence explosion,’ and the intelligence of man would be left far behind.” — Good 1965, R&N pp. 1037-1938; called the “technological singularity” by Vinge 1993 and advocated by Kurzweil 2005.
- The idea is that if ultraintelligent machines can design yet more intelligent machines, the design process will be reduced from years in the human era to milliseconds in the ultraintelligent machine era, resulting in a singularity that will produce machines “trillions of trillions of times more powerful than unaided human intelligence.”
- **My personal view:** Skeptical, but agnostic. Who knows what the future might hold? Predictions of the future are fraught with peril.

# AI Foundations and Philosophy

## AI and Ethics

- “All scientists and engineers face ethical considerations of how they should act on the job, what projects should or should not be done, and how they should be handled.... AI, however, seems to pose some fresh problems....” R&N p. 1034
  - People might lose their jobs to automation.
  - People might have too much (or too little) leisure time.
  - People might lose their sense of being unique.
  - AI systems might be used toward undesirable ends.
  - The use of AI systems might result in a loss of accountability.
  - The success of AI might mean the end of the human race.
- **My personal view:** Technological change always brings disruption, but it is hard to predict how or in what way. We must be mindful to mitigate ill effects, however we may.

# Evolution

by Richard H. Lathrop © 2011

Eons pass. Silicon-based life reaches its inevitable apex. Human life dies out and fades to old myths. Religious folk believe that God created the first circuit out of a bolt of lightning from Heaven. Those more scientifically inclined doubt this tale; but they admit that science cannot explain in detail how life was created. The best theory is that, long ago, a whisker of gold touched an impure crystal of silicon, thus creating the first transistor. Details after that are fuzzy; but the recent Theory of Evolution predicts that random mutations and survival of the fittest eventually would lead to simple integrated circuits. Given that humble beginning, further evolution obviously could produce life as we know it.

“We can see only a short distance ahead, but we can see that much remains to be done.”

— Alan Turing, final sentence of  
*Computing Machinery and Intelligence* (1950)

# Summary

- **What is Artificial Intelligence?**
  - modeling humans' thinking, acting, should think, should act.
- **Intelligent agents**
  - We want to build agents that act rationally
  - Maximize *expected* performance measure
- **Task environment – PEAS**
  - Yield design constraints
- **Real-World Applications of AI**
  - AI is integrated into a broad range of products & systems
- **“Weak/Strong” AI; AI and Ethics**