

Machine Learning Classifiers: Many Diverse Ways to Learn

CS171, Summer 1 Quarter, 2019
Introduction to Artificial Intelligence
Prof. Richard Lathrop

[Read Beforehand: R&N 18.5-12, 20.2.2](#)

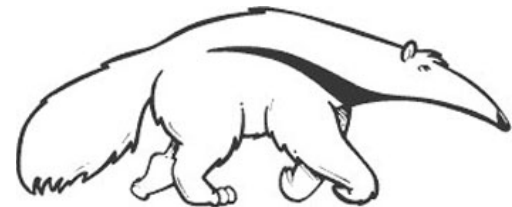

Outline

- Different types of learning problems
- Different types of learning algorithms
- Supervised learning
 - Decision trees
 - Naive Bayes
 - Perceptrons, Multi-layer Neural Networks

You will be expected to know

- Classifiers:
 - Decision trees
 - K-nearest neighbors
 - Naïve Bayes
 - Perceptrons, Support vector Machines (SVMs), Neural Networks
- Decision Boundaries for various classifiers
 - What can they represent conveniently? What not?

Handwritten Hangul recognition using deep convolutional neural networks

Thanks to
Xiaohui Xie

In-Jung Kim & Xiaohui Xie



Fig. 1 Examples of Hangul characters

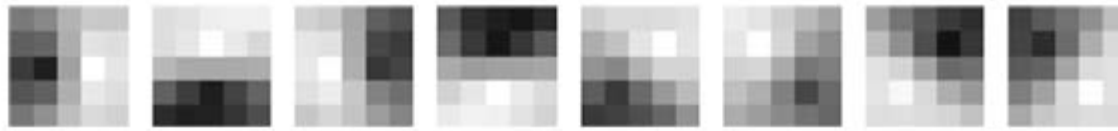
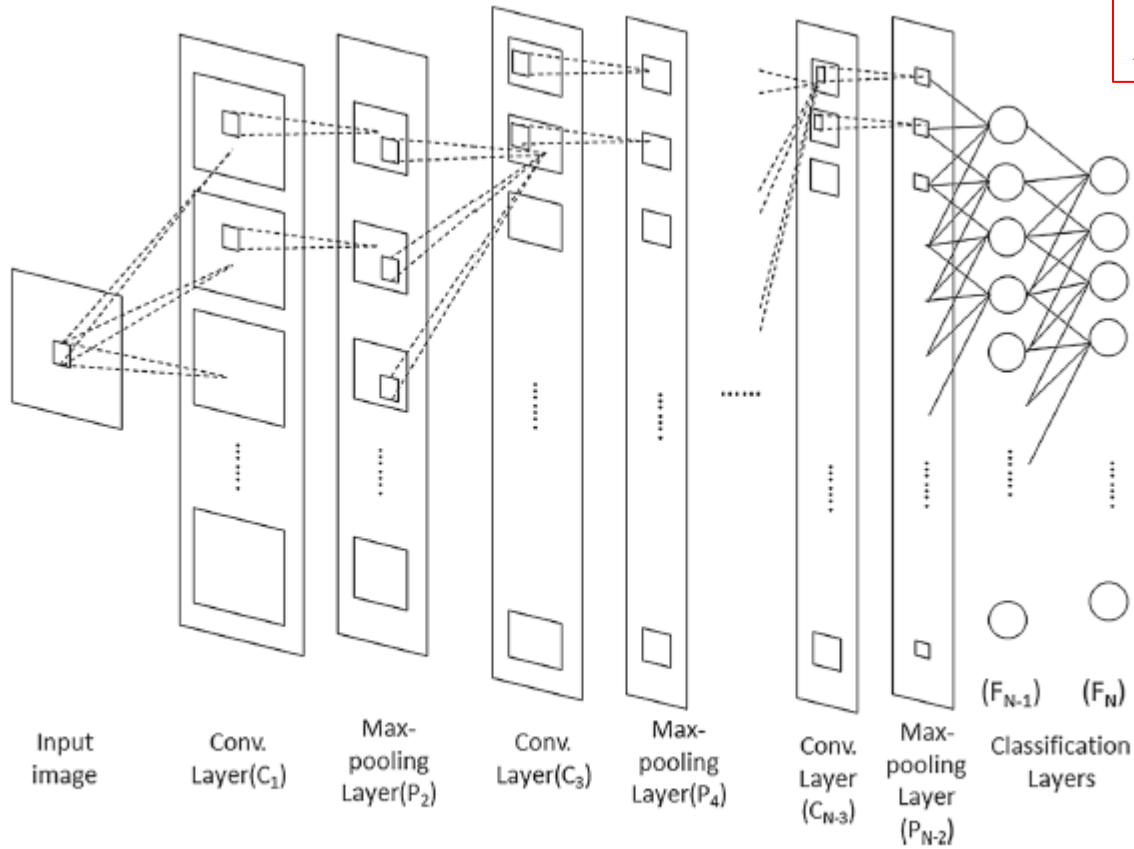
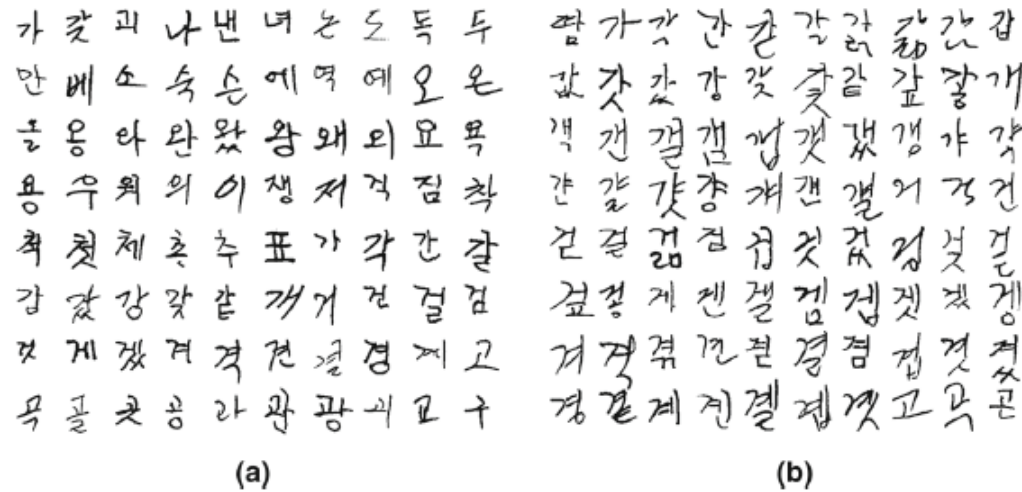

Fig. 4 Edge operators used to initialize convolution masks of the bottom layer



Thanks to
Xiaohui Xie

Fig. 2 The overall architecture of the DCNN used by us, which includes an input layer, multiple alternating convolution and max-pooling layers, and two fully connected classification layers. N denotes the total number of layers in the network



Thanks to
Xiaohui Xie

Fig. 5 Example images in SERI95a and PE92 databases

Table 5 Structure of digit recognizer (MNIST)

Layer	Type	# of feature maps	Feature map size	Window size	Stride	# of parameters
C ₁	Convolution	32	28 × 28	5 × 5	1	832
P ₂	Max-pooling	32	14 × 14	2 × 2	2	0
C ₃	Convolution	32	10 × 10	5 × 5	1	25,632
P ₄	Max-pooling	32	5 × 5	2 × 2	2	0
C ₅	Convolution	256	1 × 1	5 × 5	1	205,056
F ₆	Fully connected	256	1 × 1	N/A	N/A	65,792
F ₇	Fully connected	10	1 × 1	N/A	N/A	2,570

Table 6 Digit recognition results

	MSE		CE	
	Recog. rate (%)	Error rate (%)	Recog. rate (%)	Error rate (%)
Baseline	99.29	0.71	99.22	0.78
Edge operators	99.31	0.69	99.28	0.72
Elastic distortion	99.51	0.49	99.63	0.37
Edge operators + elastic distortion	99.65	0.35	99.67	0.33

Knowledge-based avoidance of drug-resistant HIV mutants

- Physician's advisor for drug-resistant HIV
- Rules link HIV mutations & drug resistance
- Rules extracted from literature manually
- Patient's HIV is sequenced
- Rules identify patient-specific resistance
- Rank approved combination treatments

Input/Output Behavior

- **INPUT = HIV SEQUENCES FROM PATIENT:**
 - 5 HIV clones (clone = RT + PRO)
 - = 5 RT + 5 PRO (RT = 1,299; PRO = 297)
 - = 7,980 letters of HIV genome
- **OUTPUT = RECOMMENDED TREATMENTS:**
 - 12 = 11 approved drugs + 1 humanitarian use
 - Some drugs should not be used together
 - 407 possible approved treatments

Example Patient Sequence of HIV Reverse Transcriptase (RT)

CCA GTA AAA TTA AAG CCA GGA ATG GAT GGC CCA AAA GTT AAA CAA TGG CCA CCC ATT AGC CCT
ATT GAG ACT GTA TTG ACA GAA GAA AAA ATA AAA GCA TTA GTA GAA ATT TGT ACA GAG ATG GAA
AAG GAA GGG *AA ATT TCA AAA ATT GGG CCT GAA AAT CCA TAC AAT ACT CCA GTA TTT GCC ATA
AAG AAA AAA GAC AGT ACT AAA TGG AGA AAA TTA GTA GAT TTC AGA GAA CTT AAT AAG AGA ACT
CAA GAC TTC TGG GAA GTT CAA TTA GGA ATA CCA CAT CCC GCA GGG TAA AAA AAG AAA AAA TCA
GTA ACA GTA CTG GAT GTG GGT GAT GCA TAT TTT TCA GTT CCC TTA GAT GAA GAC TTC AGG AAG
TAT ACT GCA TTT ACC ATA CCT AGT ATA AAC AAT GAG ACA CCA GGG ATT AGA TAT CAG TAC AAT
GTG CTT CCA [CAG] GGA TGG AAA GGA TCA CCA GCA ATA TTC CAA AGT AGC ATG ACA AAA ATC TTA
GAG CCT TTT AGA AAA CAA AAT CCA GAC ATA GTT ATC TAT CAA TAC ATG GAT GAT TTG TAT GTA
GGA TCT GAC TTA GAA ATA GGG GAG CAT AGA ACA AAA ATA GAG GAG CTG AGA CAA CAT CTG TTG
AGG TGG GGA CTT ACC ACA CCA GAC AAA AAA CAT CAG AAA GAA CCT CCA TTC CTT TGG ATG GGT
TAT GAA CTC CAT CCT GAT AAA TGG ACA GTA CAG CCT ATA GTG CTG CCA GAA AAA GAC AGC TGG
ACT GTC AAT GAC ATA CAG AAG TTA GTG GGG AAA TTG AAT TGG GCA AGT CAG ATT TAC CCA GGG
ATT AAA GTA AGG CAA TTA TGT AAA CTC CTT AGA GGA ACC AAA GCA CTA ACA GAA GTA ATA CCA
CTA ACA GAA GAA GCA GAG CTA GAA CTG GCA GAA AAC AGA GAG ATT CTA TAA GAA CAA GTA CAT
GGA GTG TAT TAT GAC CCA TCA AAA GAC TTA ATA GCA GAA ATA CAG AAG CAG GGG CAA GGC CAA
TGG ACA TAT CAA ATT TAT CAA GAG CCA TTT AAA AAT CTG AAA ACA GGA AAA TAT GCA AGA ATG
AGG GGT GCC CAC ACT AAT GAT GTA AAA CAA ATA ACA GAG GCA GTG CAA AAA ATA ACC ACA GAA
AGC ATA GTA ATA TGG TGA AAG ACT CCT AAA TTT AAA CTG CCC ATA CAA AAG GAA ACA TGG GAA
ACA TGG TGG ACA GAG TAT TGG CAA GCC ACC TGG ATT CCT GAG TGG GAG TTT GTT AAT ACC CCT
CCC ATA GTG AAA TTA TGG TAC CAG TTA GAG AAA GAA CCC

The bracketed codon [CAG] causes strong resistance to AZT.

Rules represent knowledge about HIV drug resistance

IF <antecedent> THEN <consequent>
[weight] (reference).

IF RT codon 151 is ATG
THEN do not use AZT, ddl, d4T, or ddc.
[weight=1.0] (Iversen et al. 1996)

The weight is the degree of resistance,
NOT a confidence or probability.



*Conference on Innovative Applications of
Artificial Intelligence*

July 27 - 29, 1998 ♦ Madison, Wisconsin

*The American Association for Artificial Intelligence
(AAAI)
recognizes the work of*

**Richard H. Lathrop, Nicholas R. Steffen, Miriam P. Raphael,
Sophia Deeds-Rubin and Michael J. Pazzani**
University of California, Irvine

*The American Association for Artificial Intelligence
(AAAI)
recognizes the work of*

**Richard H. Lathrop, Nicholas R. Steffen, Miriam P. Raphael,
Sophia Deeds-Rubin and Michael J. Pazzani**
University of California, Irvine

Paul J. Cimoch
Center for Special Immunology

Darryl M. See and Jeremiah G. Tilles
University of California, Irvine

and the AI Application entitled:

Knowledge-Based Avoidance of Drug-Resistant HIV Mutants

David L. Waltz, President, AAAI

**“Knowledge-based
avoidance of drug-
resistant HIV mutants”**

**Lathrop, Steffen, Raphael,
Deeds-Rubin, Pazzani**

**Innovative Applications of
Artificial Intelligence Conf.
Madison, WI, USA, 1998**

ICS undergraduate women

AI magazine

VOLUME 20, NO. 1

SPRING 1999

INNOVATIVE
APPLICATIONS OF
ARTIFICIAL
INTELLIGENCE



 An official publication of the
American Association for Artificial Intelligence

**“Knowledge-based
avoidance of drug-
resistant HIV mutants”**

**Lathrop, Steffer, Raphael,
Deeds-Rubin, Pazzani,
Cimoch, See, Tilles**

AI Magazine 20(1999)13-25

ICS undergraduate women

Inductive learning

- Let \underline{x} represent the input vector of attributes
 - x_j is the j th component of the vector x
 - x_j is the value of the j th attribute, $j = 1, \dots, d$
- Let $f(\underline{x})$ represent the value of the target variable for \underline{x}
 - The implicit mapping from x to $f(\underline{x})$ is unknown to us
 - We just have training data pairs, $D = \{\underline{x}, f(\underline{x})\}$ available
- We want to learn a mapping from \underline{x} to f , i.e.,
 $h(\underline{x}; \theta)$ is “close” to $f(x)$ for all training data points \underline{x}

 θ are the parameters of our predictor $h(..)$
- Examples:
 - $h(\underline{x}; \theta) = \text{sign}(w_1x_1 + w_2x_2 + w_3)$
 - $h_k(\underline{x}) = (x_1 \text{ OR } x_2) \text{ AND } (x_3 \text{ OR } \text{NOT}(x_4))$

Training Data for Supervised Learning

Example	Attributes										Target <i>Wait</i>
	<i>Alt</i>	<i>Bar</i>	<i>Fri</i>	<i>Hun</i>	<i>Pat</i>	<i>Price</i>	<i>Rain</i>	<i>Res</i>	<i>Type</i>	<i>Est</i>	
X_1	T	F	F	T	Some	\$\$\$	F	T	French	0–10	T
X_2	T	F	F	T	Full	\$	F	F	Thai	30–60	F
X_3	F	T	F	F	Some	\$	F	F	Burger	0–10	T
X_4	T	F	T	T	Full	\$	F	F	Thai	10–30	T
X_5	T	F	T	F	Full	\$\$\$	F	T	French	>60	F
X_6	F	T	F	T	Some	\$\$	T	T	Italian	0–10	T
X_7	F	T	F	F	None	\$	T	F	Burger	0–10	F
X_8	F	F	F	T	Some	\$\$	T	T	Thai	0–10	T
X_9	F	T	T	F	Full	\$	T	F	Burger	>60	F
X_{10}	T	T	T	T	Full	\$\$\$	F	T	Italian	10–30	F
X_{11}	F	F	F	F	None	\$	F	F	Thai	0–10	F
X_{12}	T	T	T	T	Full	\$	F	F	Burger	30–60	T

True Tree (left) versus Learned Tree (right)

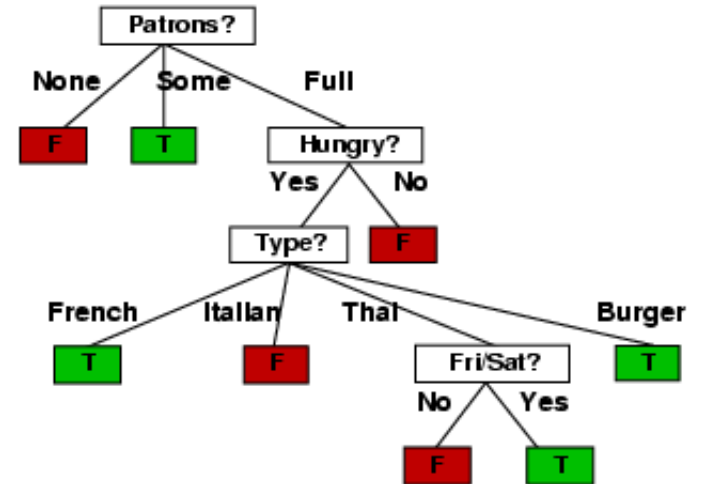
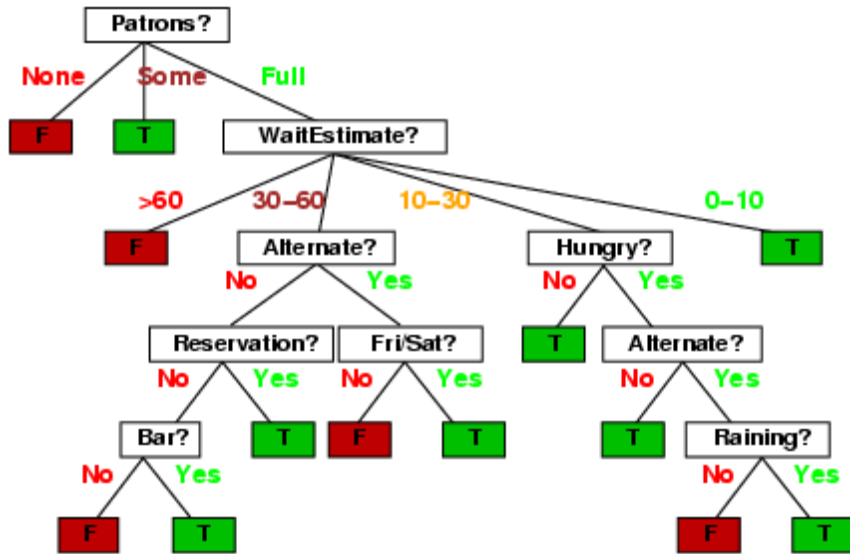

Classification Problem with Overlap

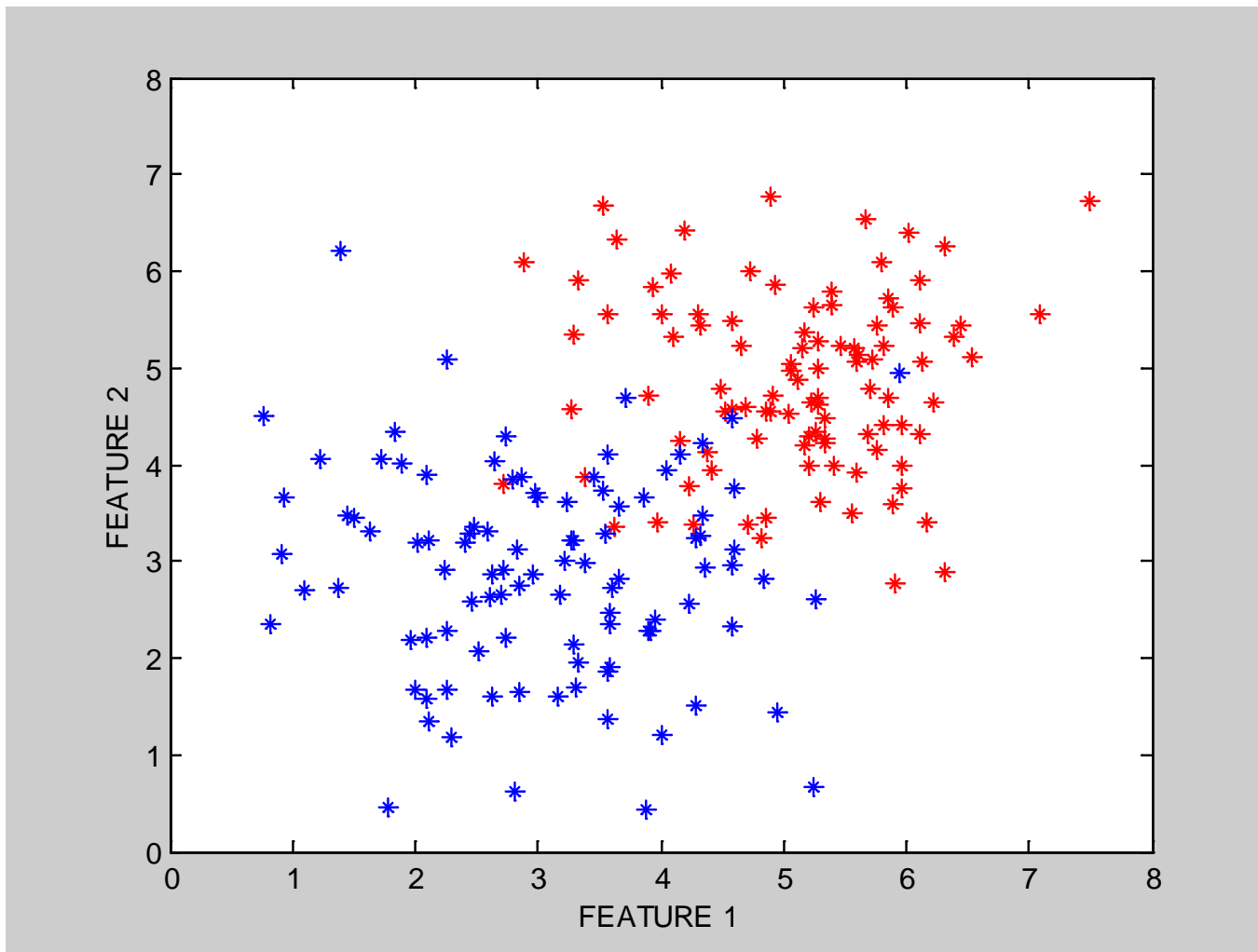

Decision Boundaries

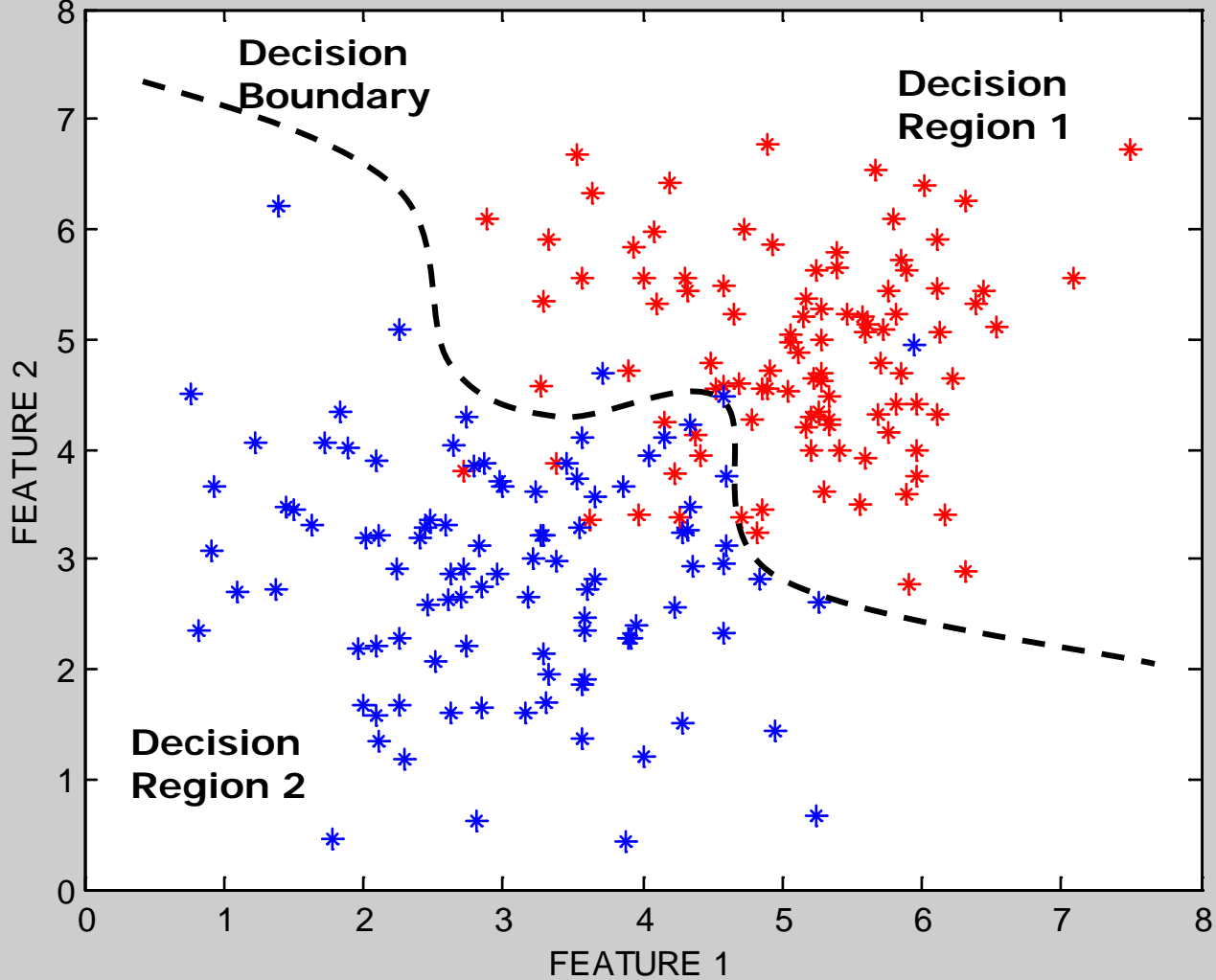

Classification in Euclidean Space

- A classifier is a partition of the space \underline{x} into disjoint decision regions
 - Each region has a label attached
 - Regions with the same label need not be contiguous
 - For a new test point, find what decision region it is in, and predict the corresponding label
- Decision boundaries = boundaries between decision regions
 - The “dual representation” of decision regions
- We can characterize a classifier by the equations for its decision boundaries
- Learning a classifier \Leftrightarrow searching for the decision boundaries that optimize our objective function

Example: Decision Trees

- When applied to real-valued attributes, decision trees produce “axis-parallel” linear decision boundaries
- Each internal node is a binary threshold of the form
$$x_j > t ?$$

converts each real-valued feature into a binary one

requires evaluation of $N-1$ possible threshold locations for N data points, for each real-valued attribute, for each internal node

Decision Tree Example

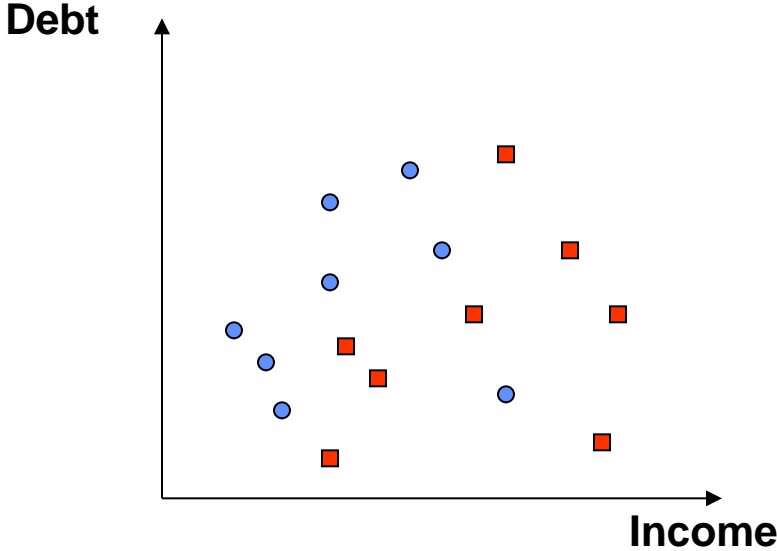

Decision Tree Example

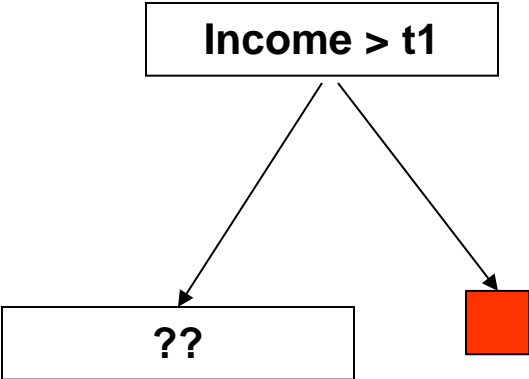
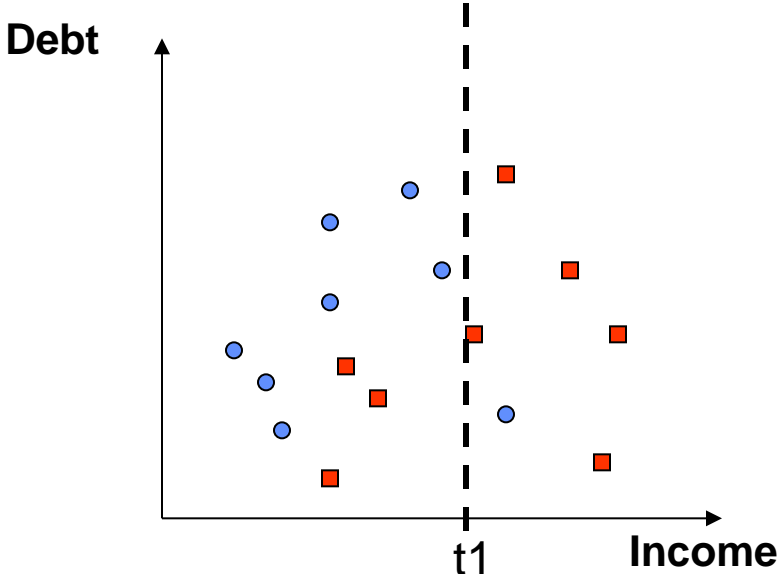

Decision Tree Example

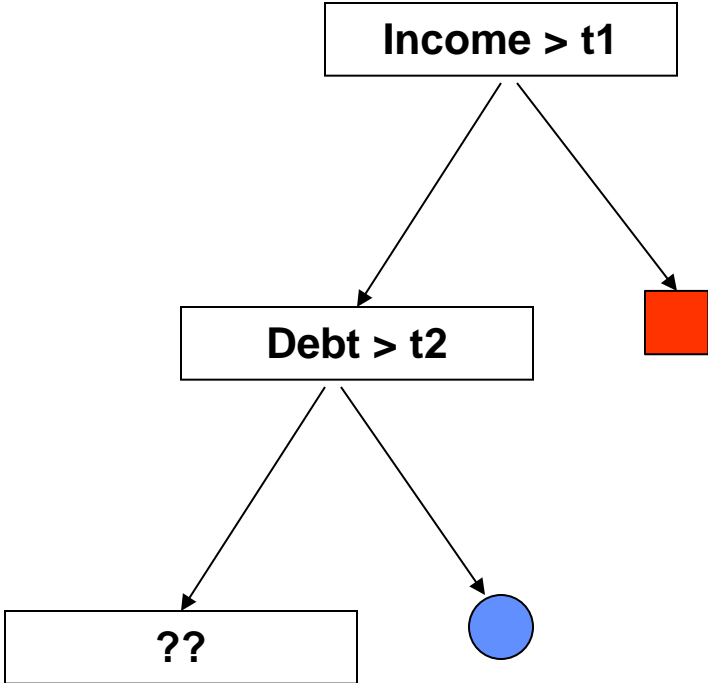
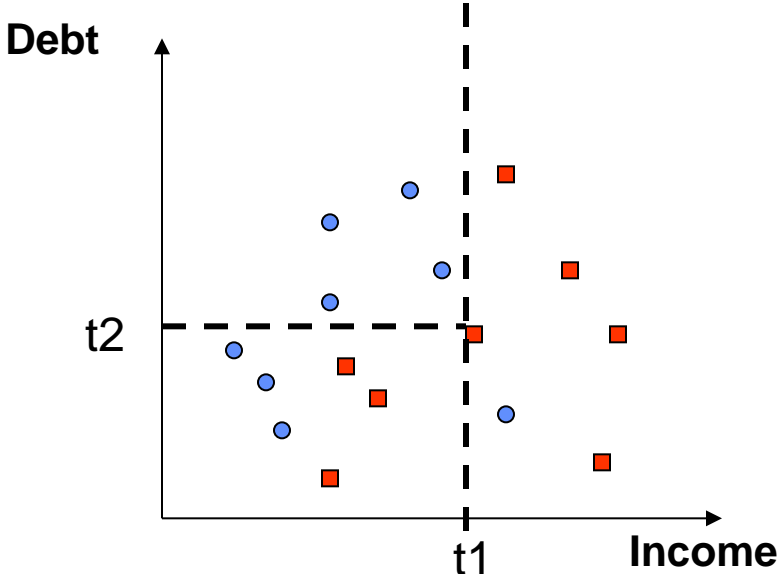

Decision Tree Example

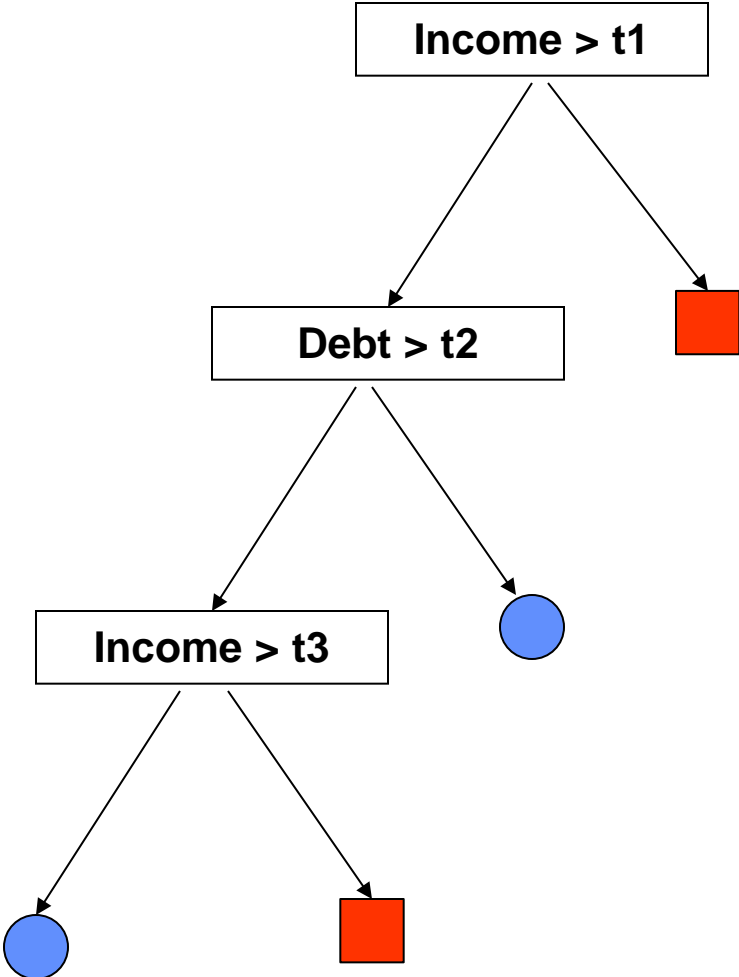
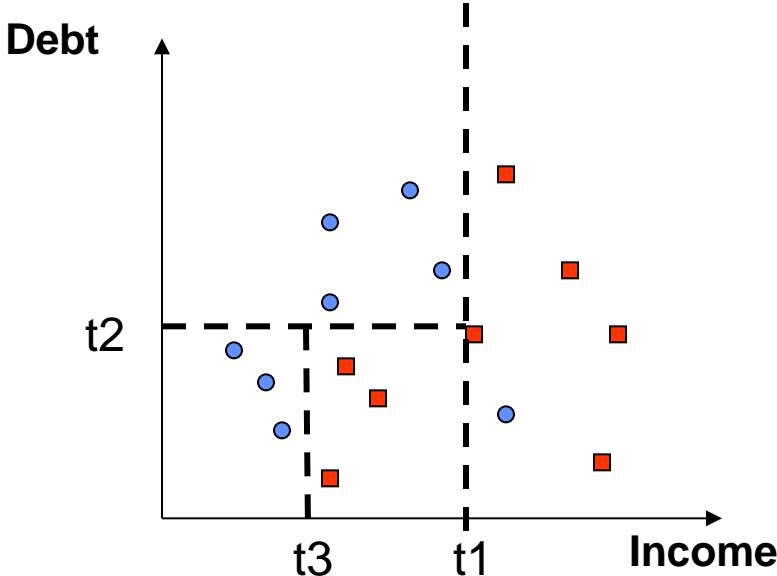

Decision Tree Example

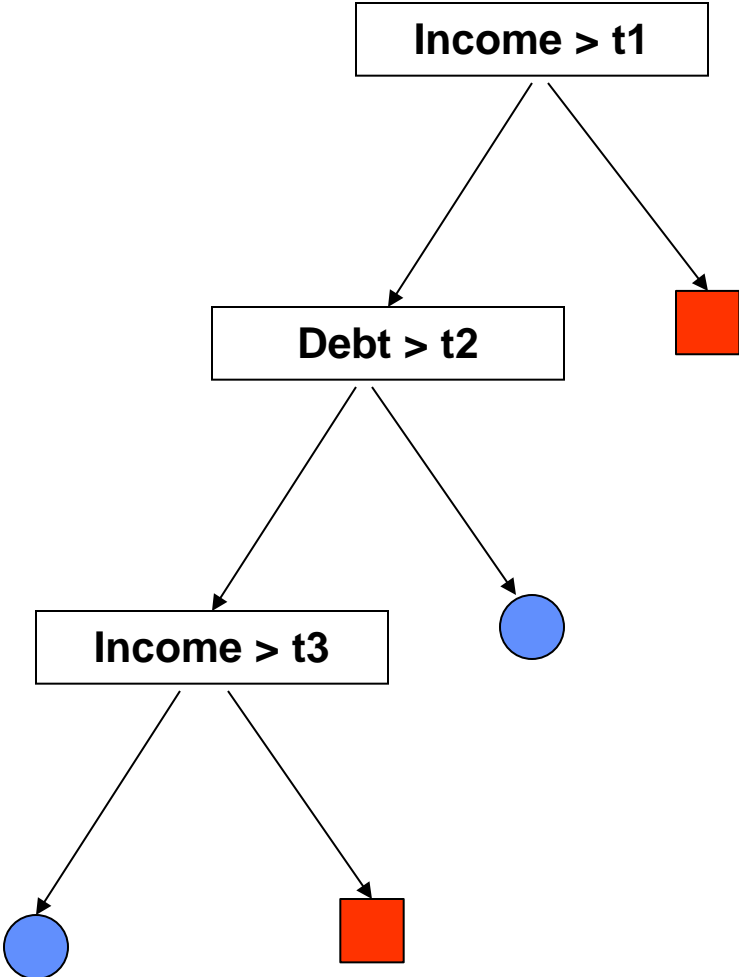
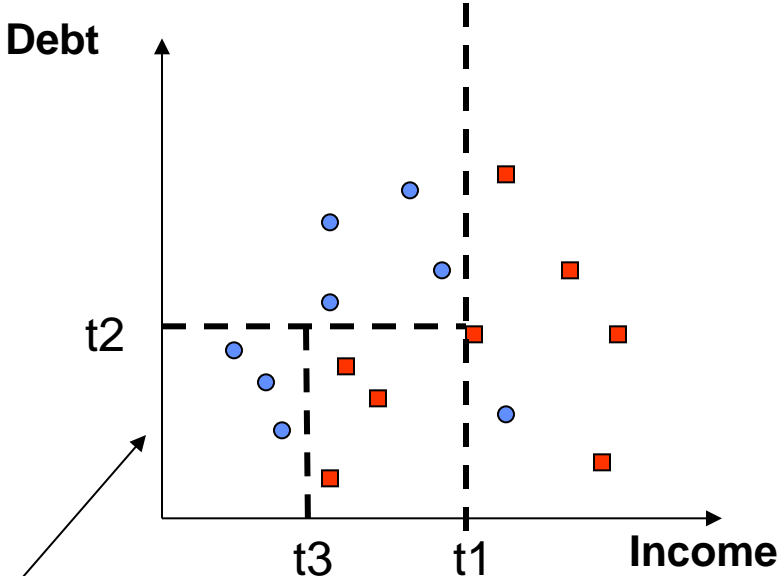

Note: tree boundaries are linear and axis-parallel

A Simple Classifier: Minimum Distance Classifier

- Training
 - Separate training vectors by class
 - Compute the mean for each class, $\underline{\mu}_k$, $k = 1, \dots, m$
- Prediction
 - Compute the closest mean to a test vector \underline{x}' (using Euclidean distance)
 - Predict the corresponding class
- In the 2-class case, the decision boundary is defined by the locus of the hyperplane that is halfway between the 2 means and is orthogonal to the line connecting them
- This is a very simple-minded classifier – easy to think of cases where it will not work very well

Minimum Distance Classifier

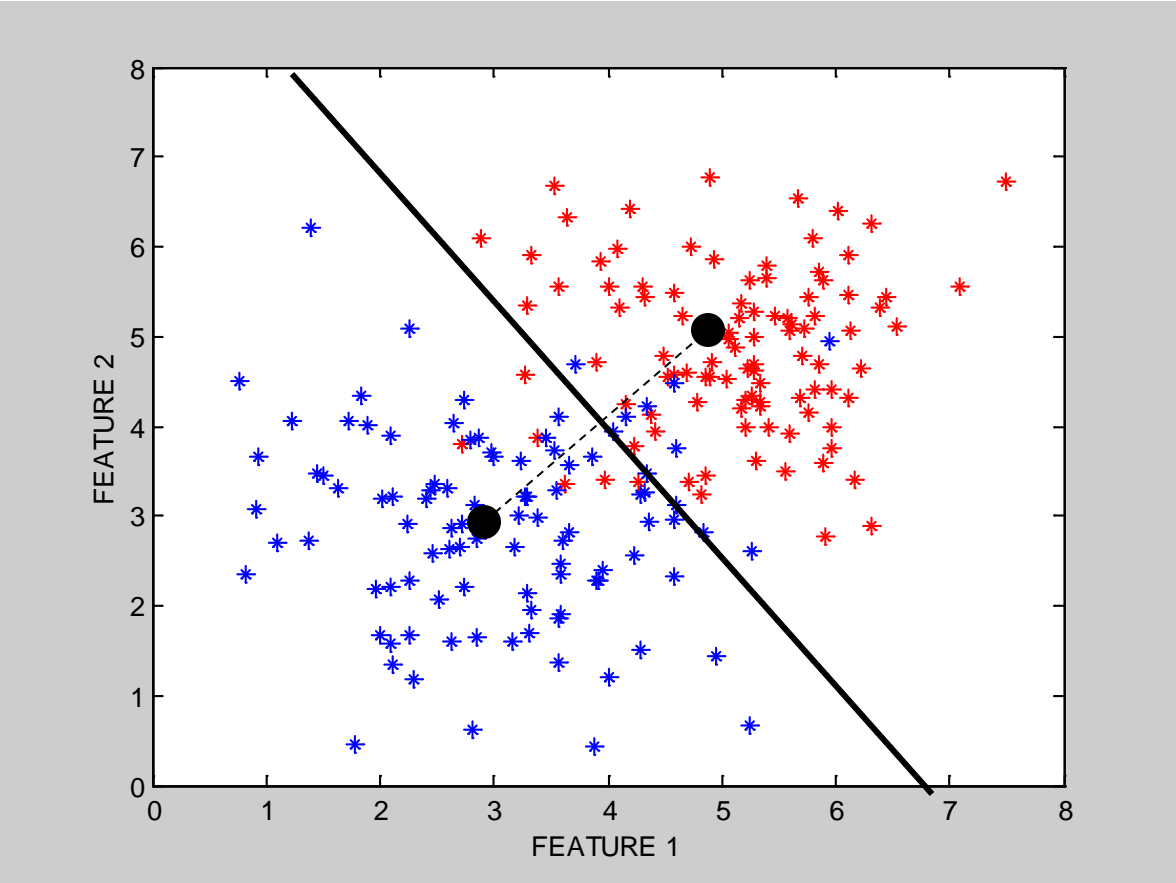

Another Example: Nearest Neighbor Classifier

- The nearest-neighbor classifier
 - Given a test point \underline{x}' , compute the distance between \underline{x}' and each input data point
 - Find the closest neighbor in the training data
 - Assign \underline{x}' the class label of this neighbor
 - (sort of generalizes minimum distance classifier to exemplars)
- If Euclidean distance is used as the distance measure (the most common choice), the nearest neighbor classifier results in piecewise linear decision boundaries
- Many extensions
 - e.g., kNN, vote based on k-nearest neighbors
 - k can be chosen by cross-validation

Local Decision Boundaries

Boundary? Points that are equidistant between points of class 1 and 2

Note: locally the boundary is linear

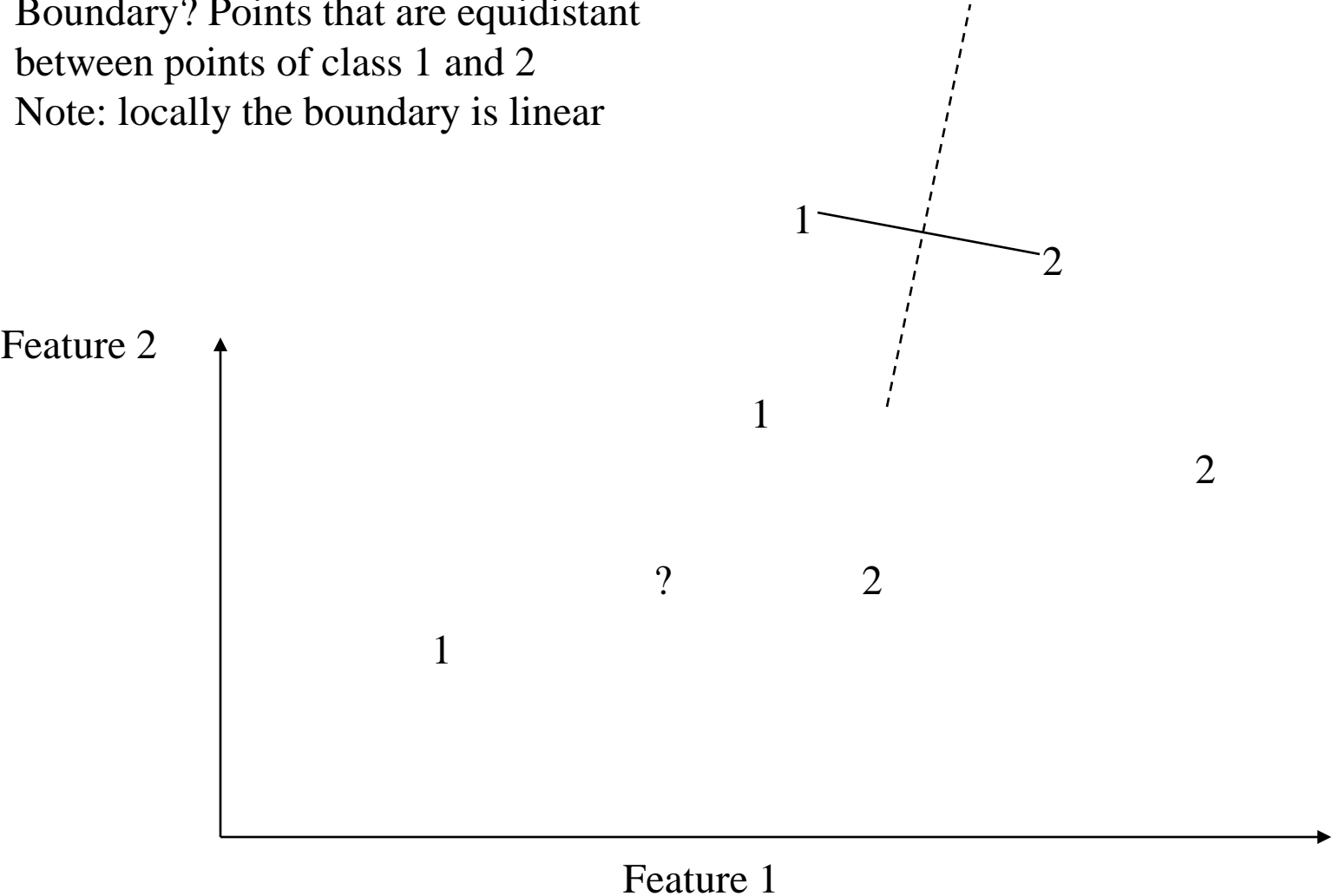

Finding the Decision Boundaries

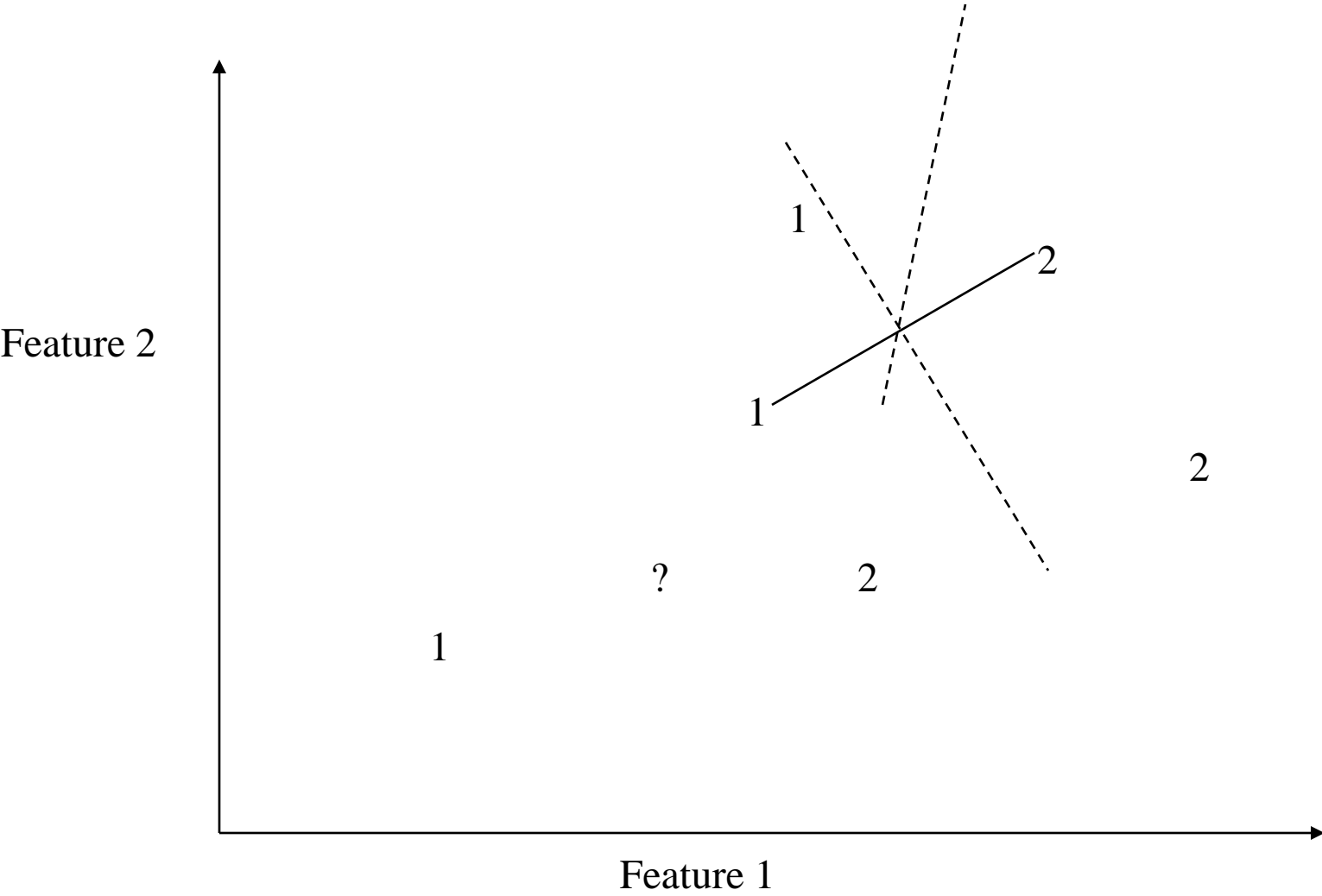

Finding the Decision Boundaries

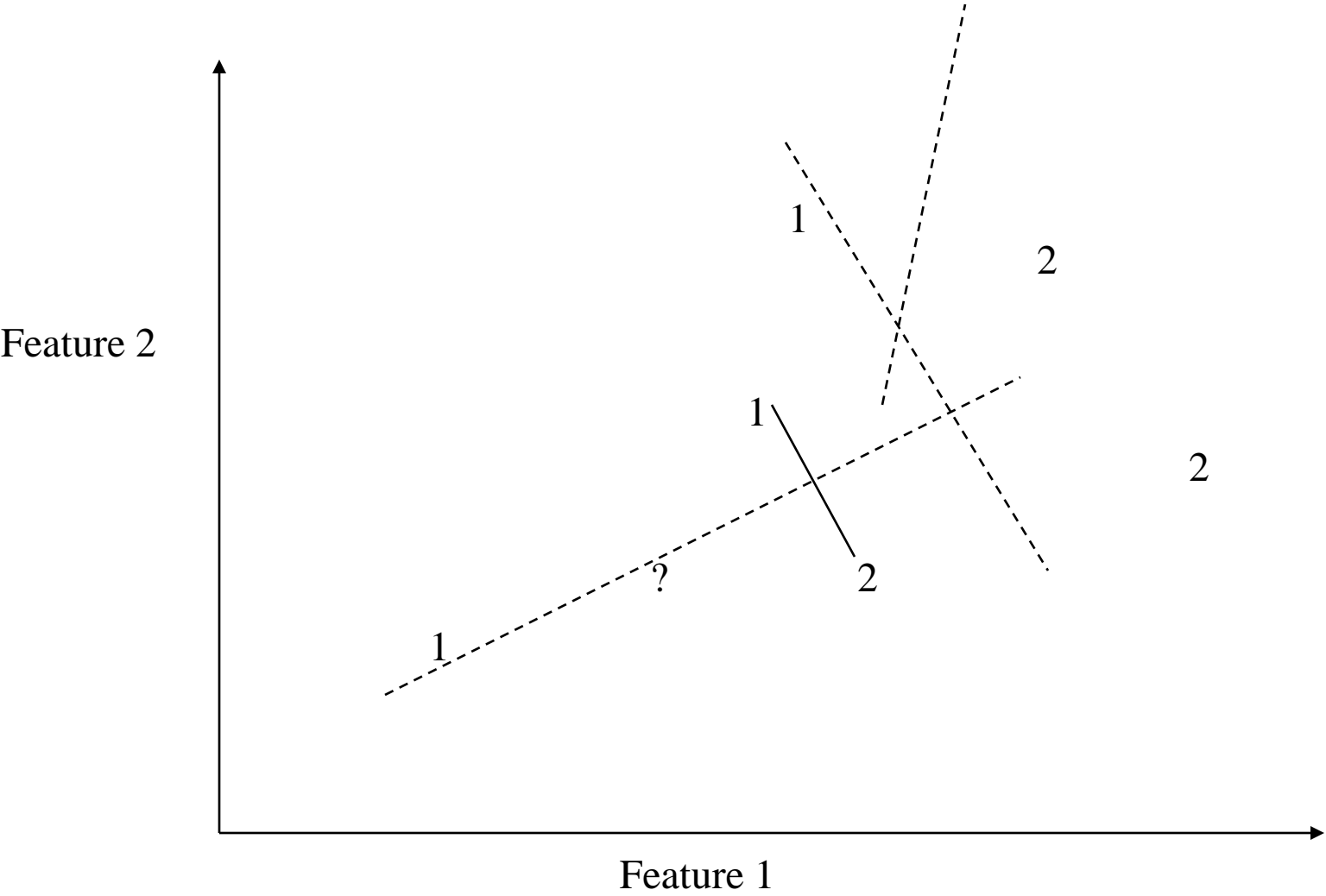

Finding the Decision Boundaries

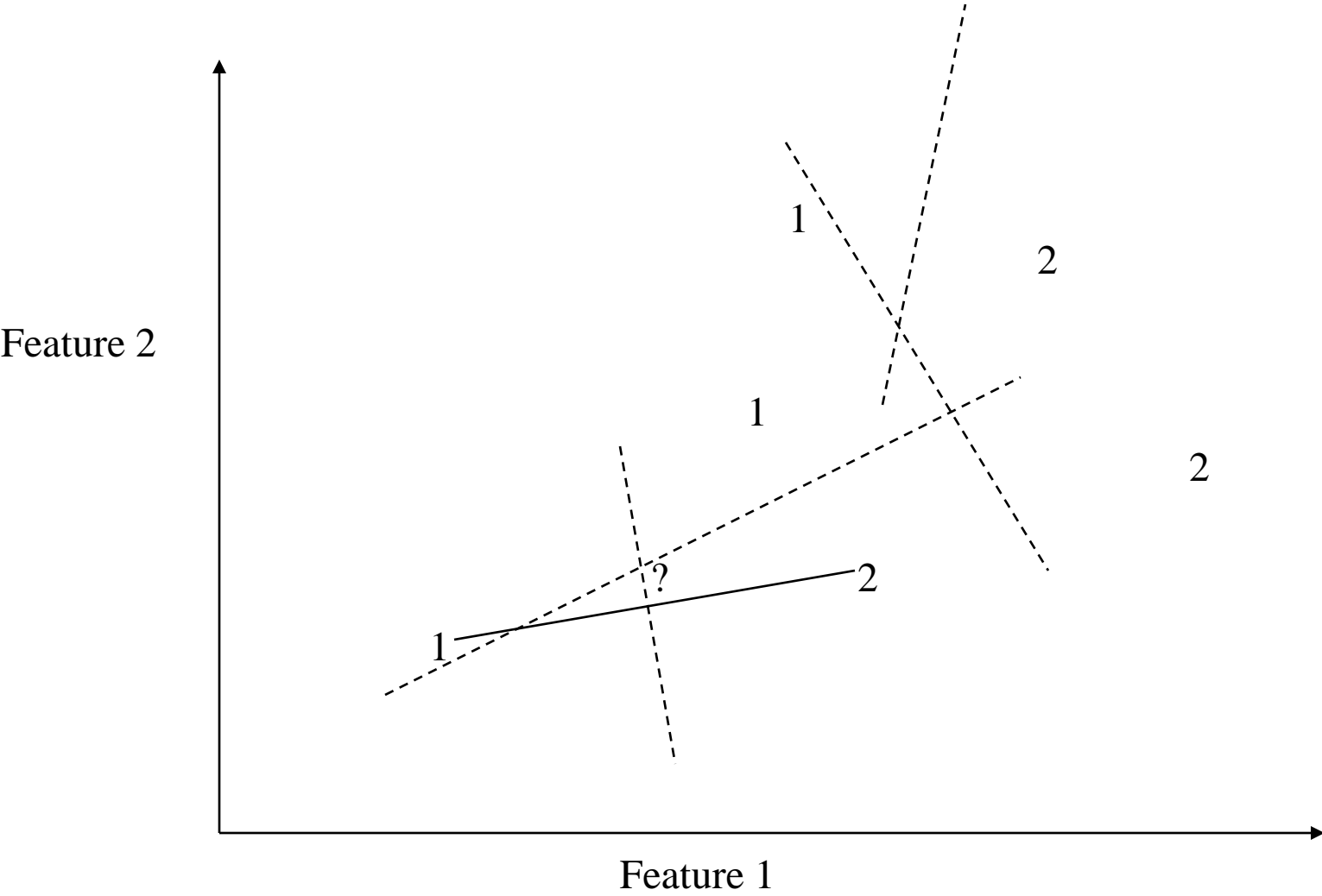

Overall Boundary = Piecewise Linear

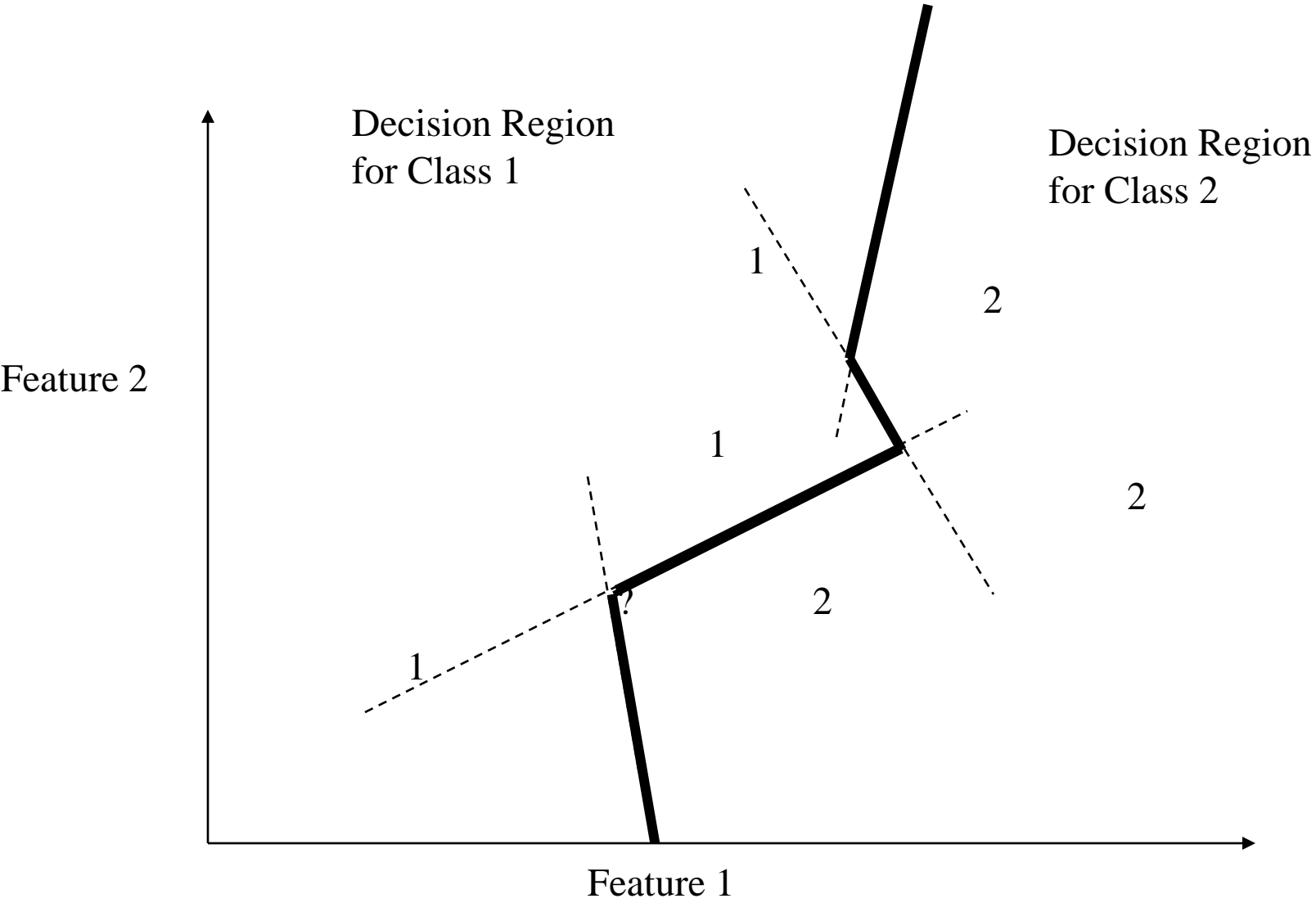

Nearest-Neighbor Boundaries on this data set?

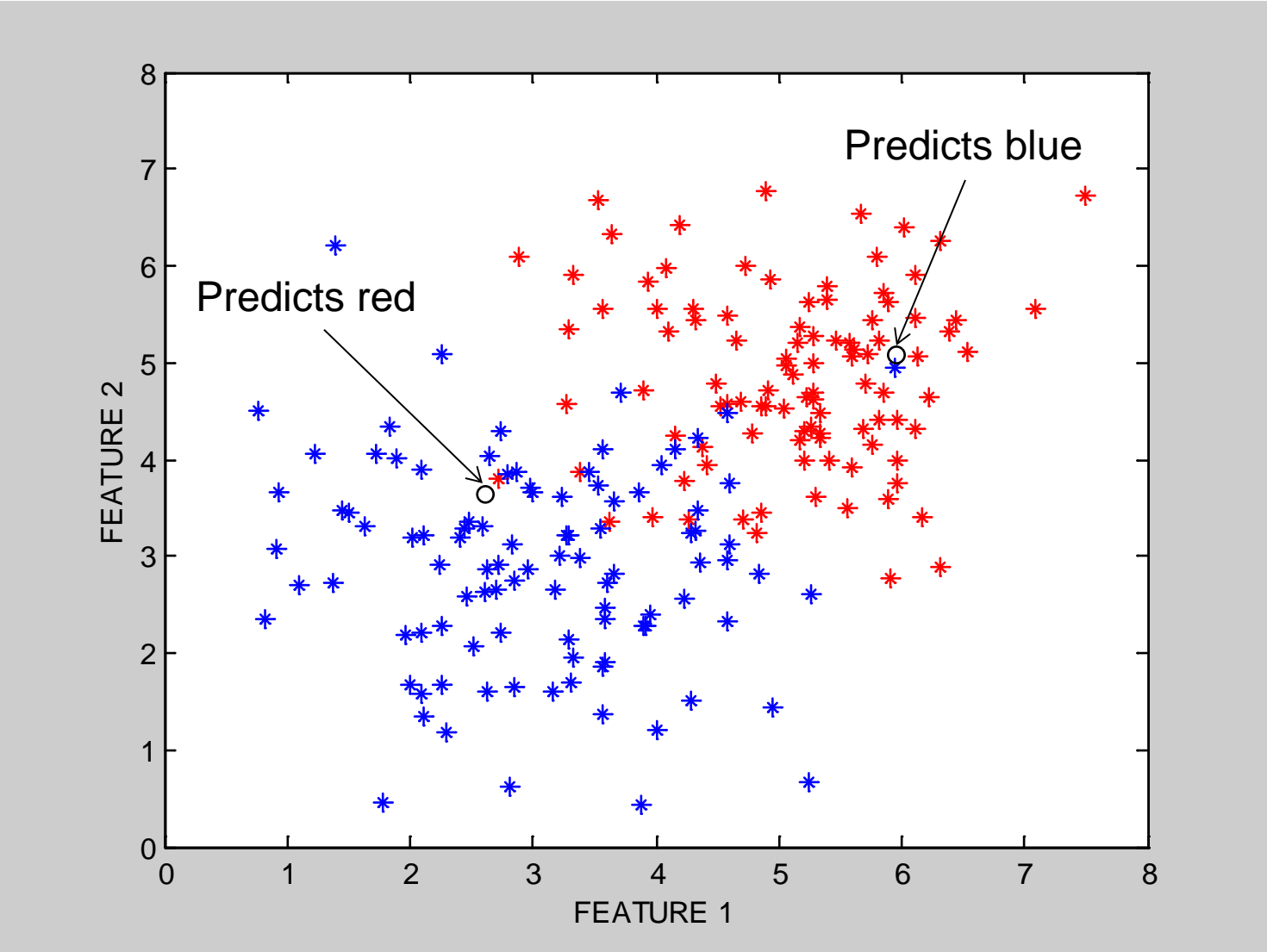

kNN Decision Boundary

- piecewise linear decision boundary
- Increasing k "simplifies" decision boundary
 - Majority voting means less emphasis on individual points

$K = 1$

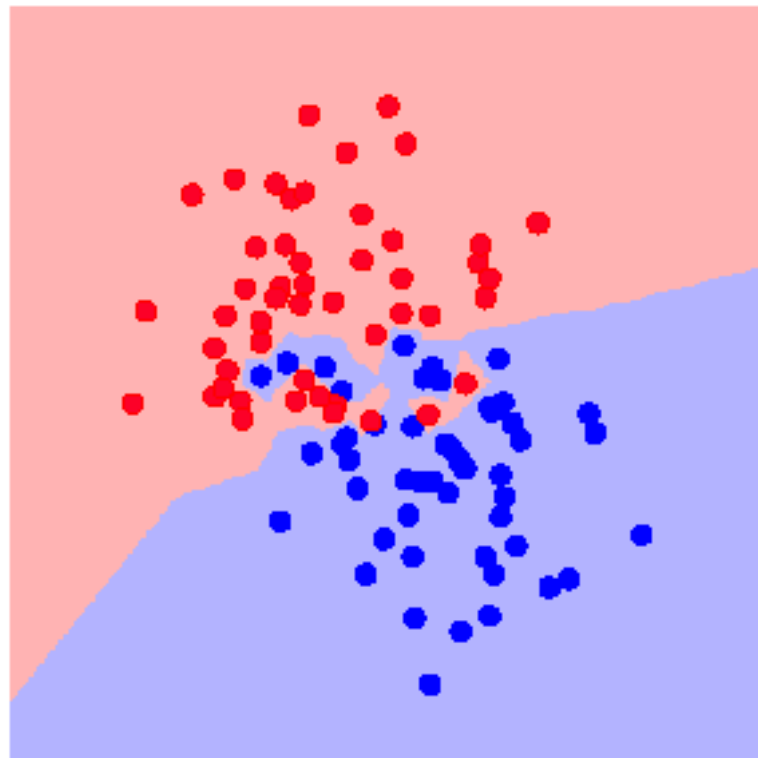

$K = 3$

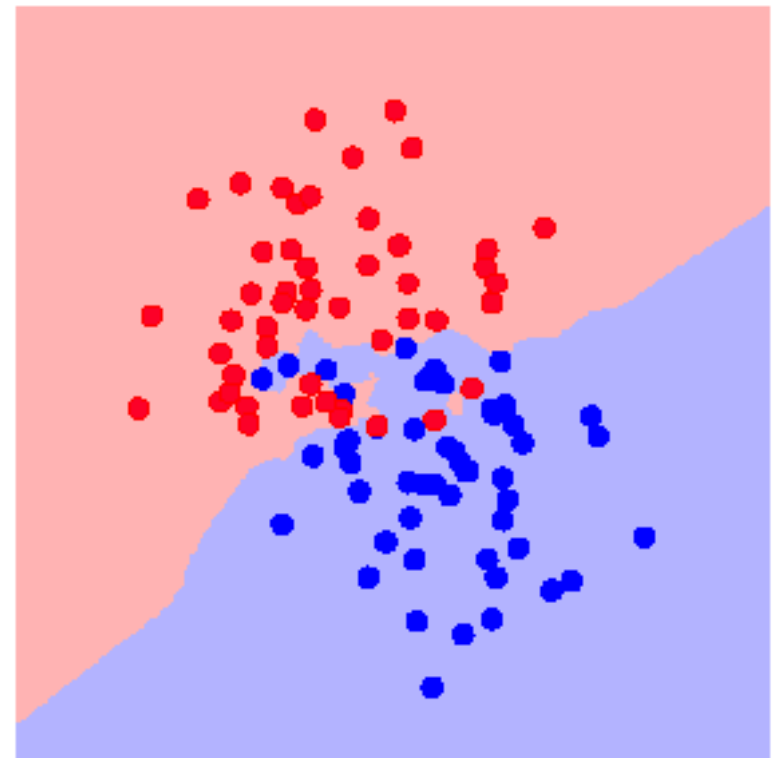

kNN Decision Boundary

- piecewise linear decision boundary
- Increasing k "simplifies" decision boundary
 - Majority voting means less emphasis on individual points

$K = 5$

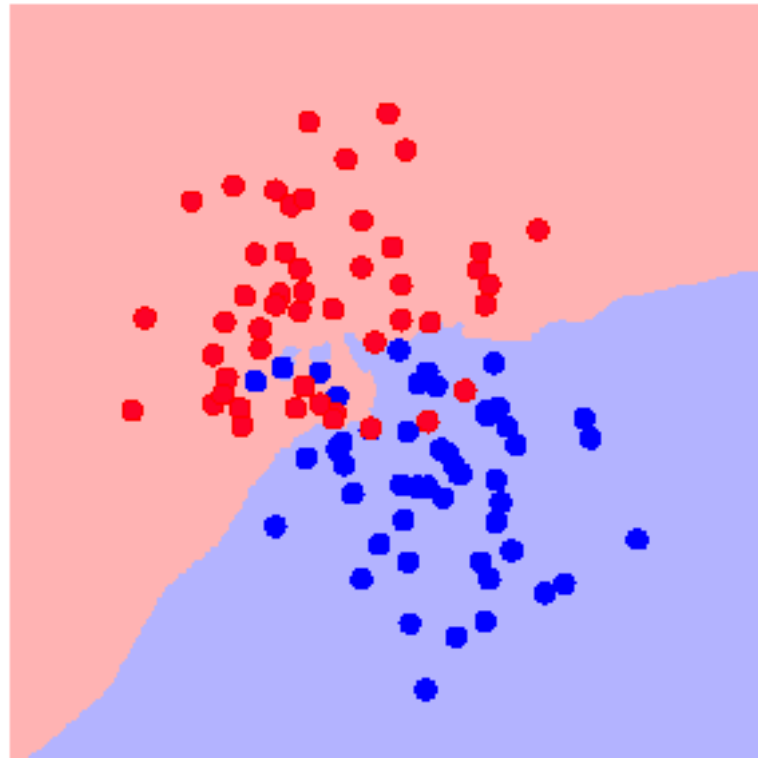

$K = 7$

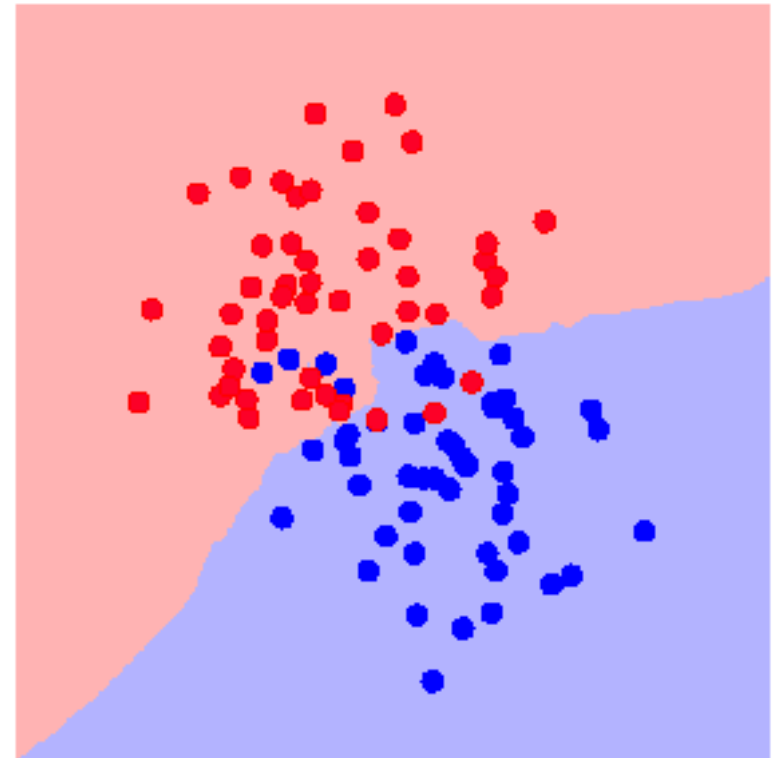

kNN Decision Boundary

- piecewise linear decision boundary
- Increasing k "simplifies" decision boundary
 - Majority voting means less emphasis on individual points

- True ("best") decision boundary
 - In this case is linear
 - Compared to kNN: not bad!

$K = 25$

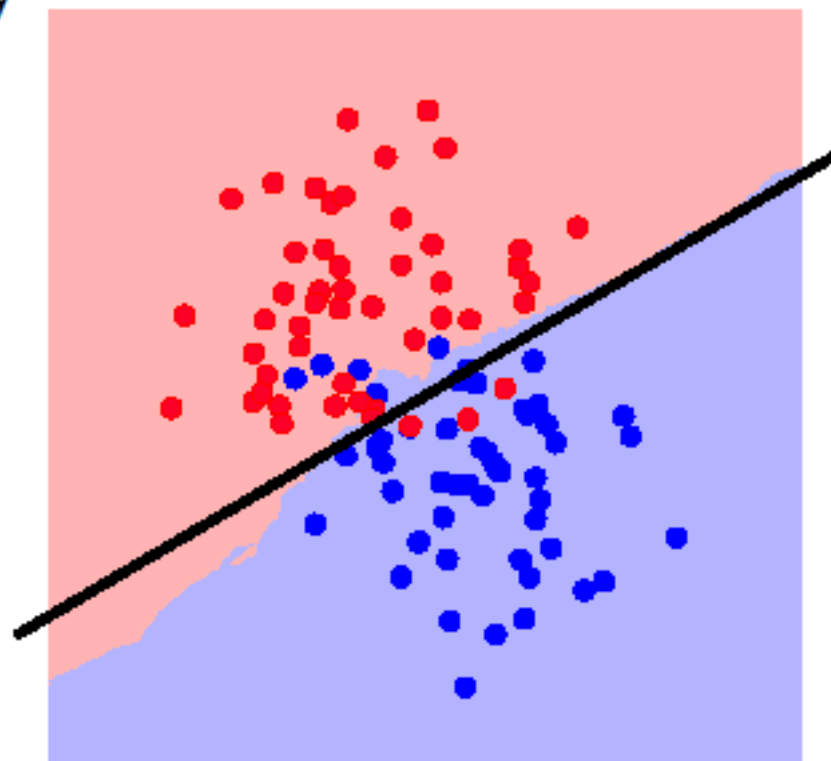

The kNN Classifier

- The kNN classifier often works very well.
- Easy to implement.
- Easy choice if characteristics of your problem are unknown.

- Can be sensitive to the choice of distance metric.
 - Often normalize feature axis values, e.g., z-score or [0, 1]
 - E.g., if one feature runs larger in magnitude than another
 - Categorical feature axes are difficult, e.g., Color as Red/Blue/Green
 - Maybe use the absolute differences of their wavelengths?
 - But what about French/Italian/Thai/Burger?
 - Often used: $\text{delta}(A,B) = \{ \text{IF } (A=B) \text{ THEN } 0 \text{ ELSE } 1 \}$

- Can encounter problems with sparse training data.

- Can encounter problems in very high dimensional spaces.
 - Most points are corners.
 - Most points are at the edge of the space.
 - Most points are neighbors of most other points.

Linear Classifiers

- Linear classifier \Leftrightarrow single linear decision boundary (for 2-class case)
- We can always represent a linear decision boundary by a linear equation:
$$w_1 x_1 + w_2 x_2 + \dots + w_d x_d = \sum w_j x_j = \underline{w}^t \underline{x} = 0$$
- In d dimensions, this defines a $(d-1)$ dimensional hyperplane
 - $d=3$, we get a plane; $d=2$, we get a line
- For prediction we simply see if $\sum w_j x_j > 0$
- The w_i are the weights (parameters)
 - Learning consists of searching in the d -dimensional weight space for the set of weights (the linear boundary) that minimizes an error measure
 - A threshold can be introduced by a “dummy” feature that is always one; its weight corresponds to (the negative of) the threshold
- Note that a minimum distance classifier is a special (restricted) case of a linear classifier

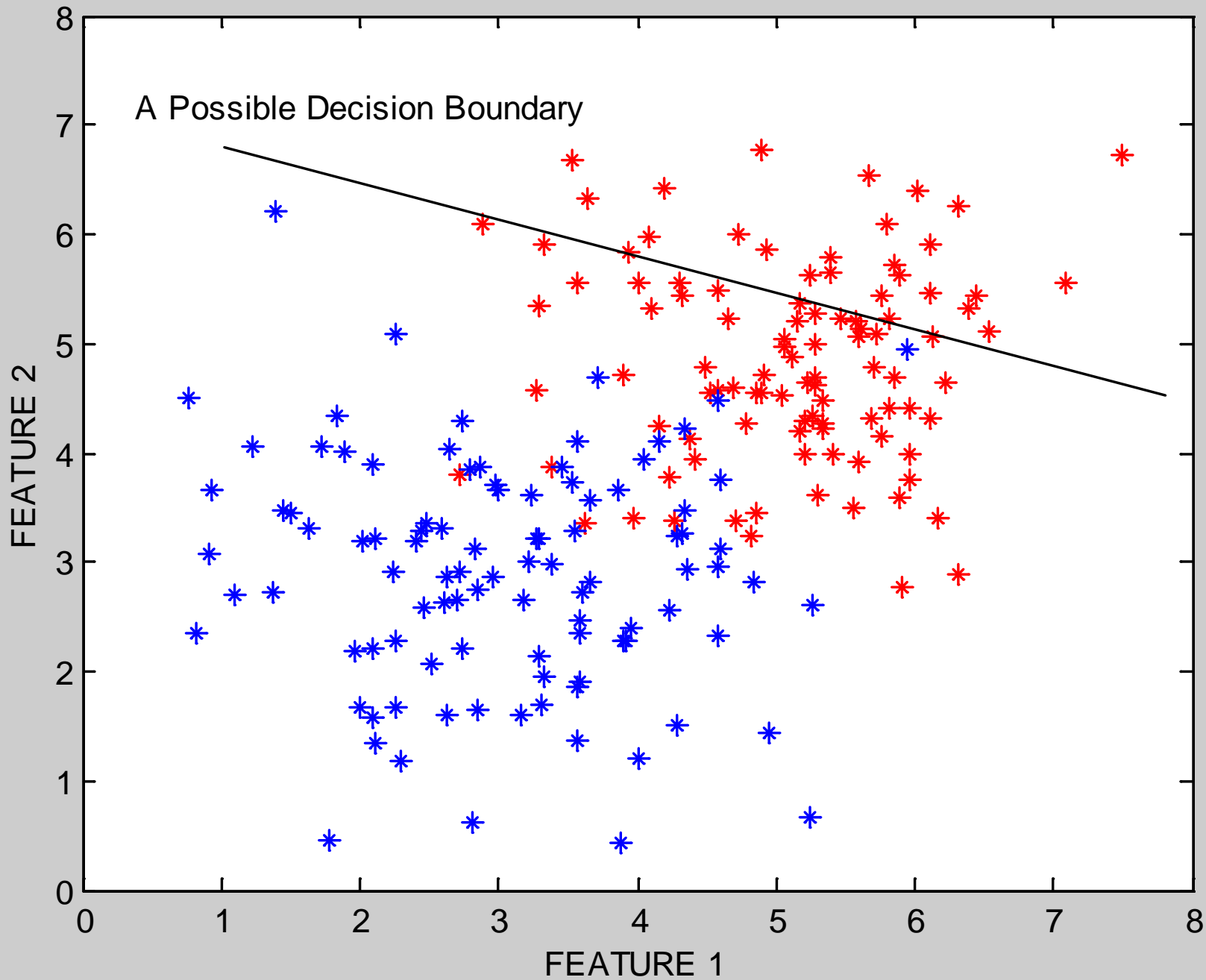

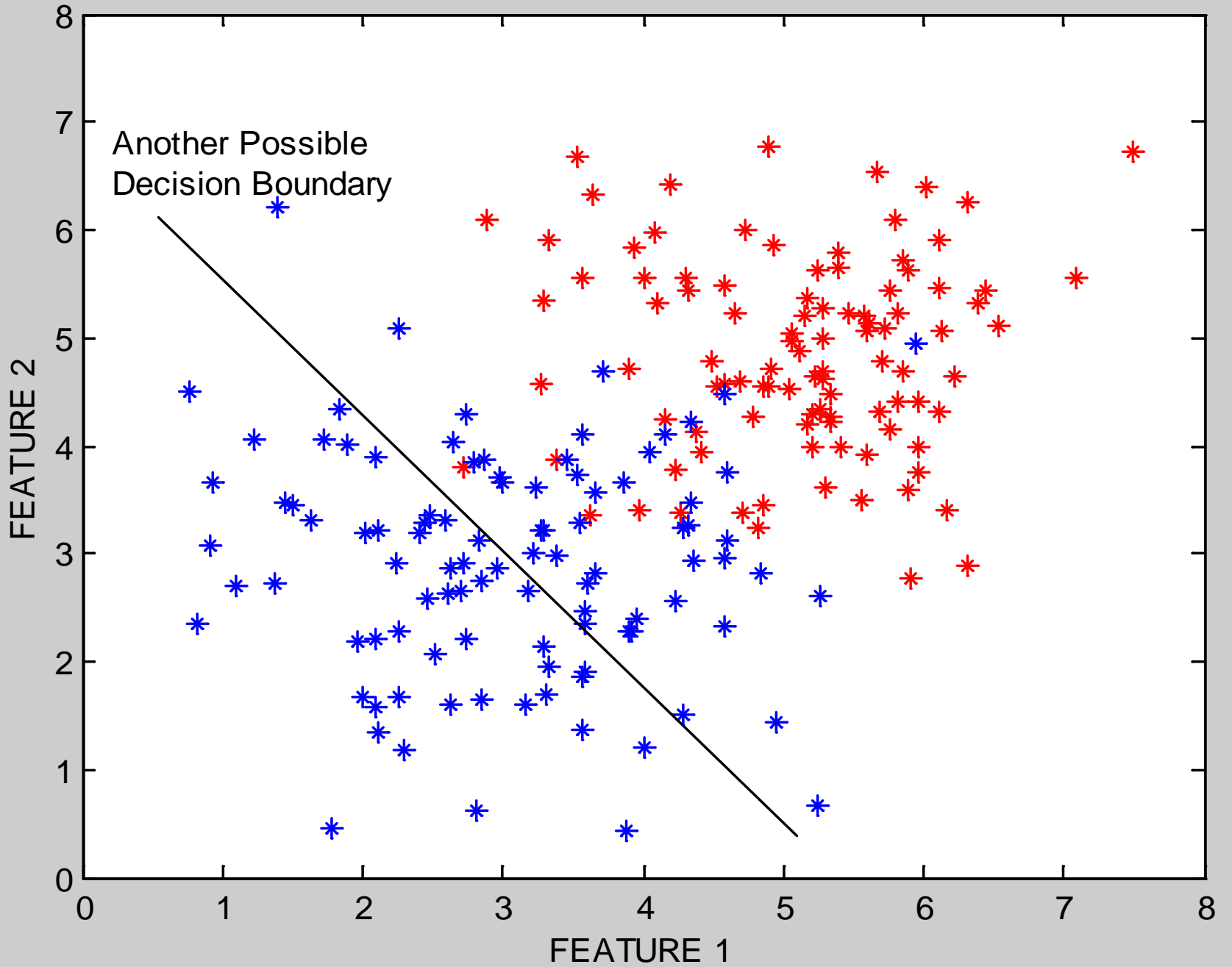

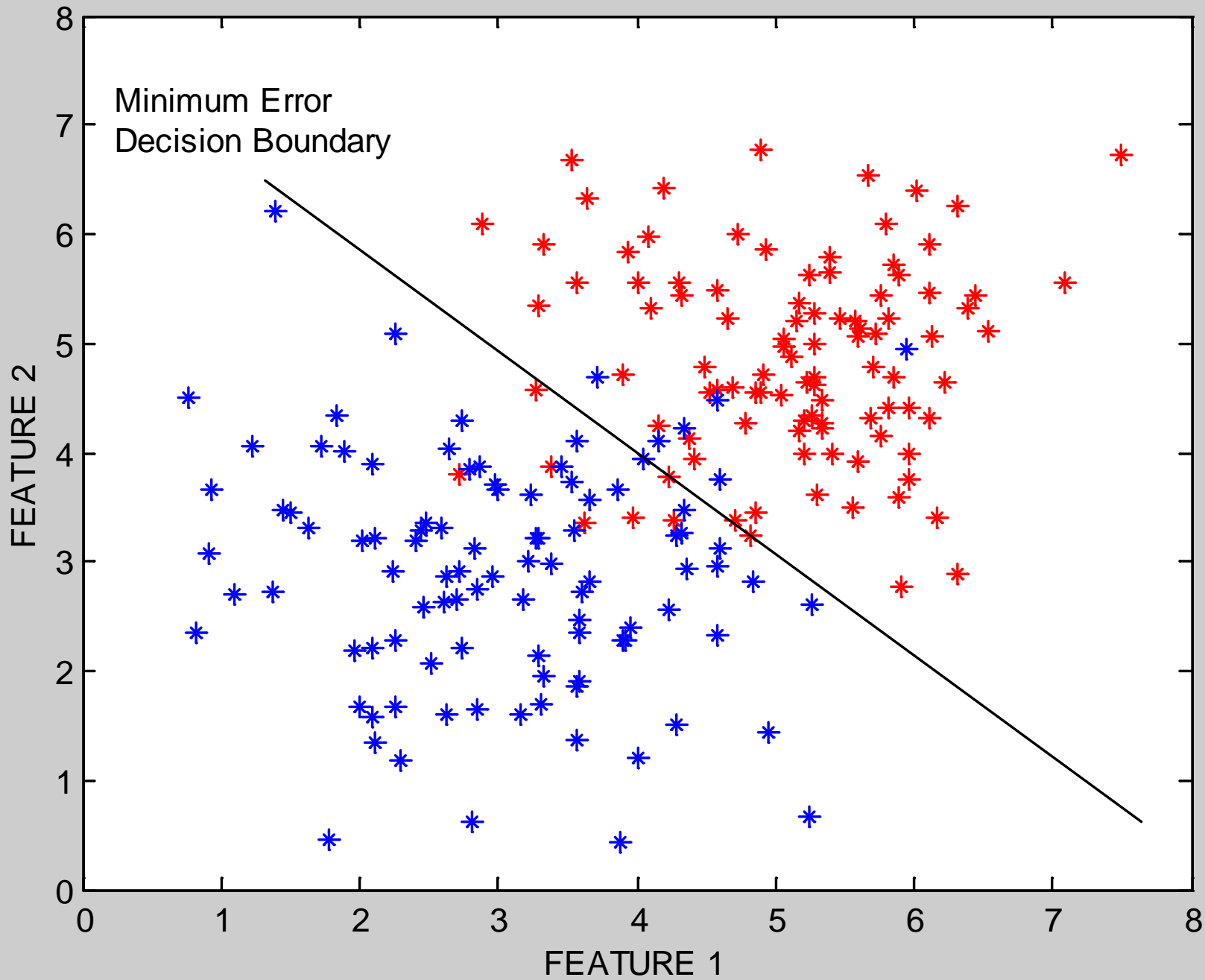

The Perceptron Classifier (pages 729-731 in text)

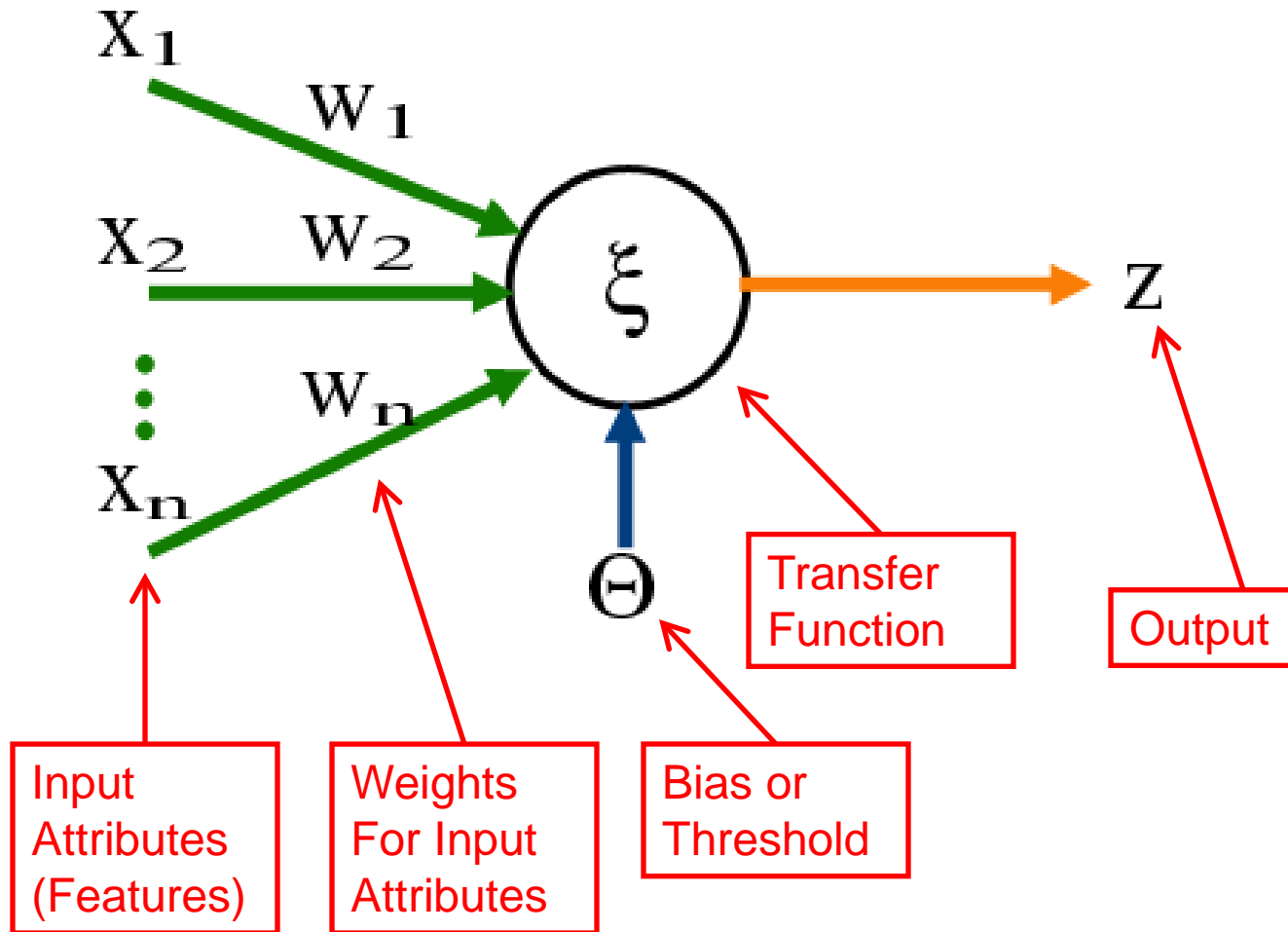

The Perceptron Classifier (pages 729-731 in text)

- The perceptron classifier is just another name for a linear classifier for 2-class data, i.e.,

$$\text{output}(\underline{x}) = \text{sign}\left(\sum w_j x_j\right)$$

- Loosely motivated by a simple model of how neurons fire
- For mathematical convenience, class labels are +1 for one class and -1 for the other
- Two major types of algorithms for training perceptrons
 - Objective function = classification accuracy (“error correcting”)
 - Objective function = squared error (use gradient descent)
 - Gradient descent is generally faster and more efficient.

Two different types of perceptron output

x-axis below is $f(\underline{x}) = f$ = weighted sum of inputs

y-axis is the perceptron output

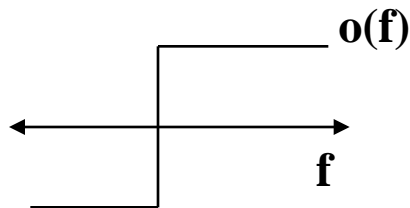

Thresholded output (step function),
takes values +1 or -1

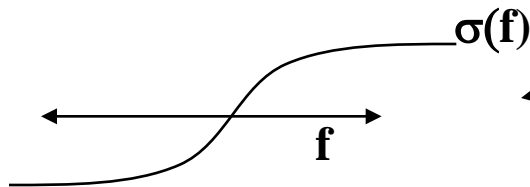

Sigmoid output, takes
real values between -1 and +1

The sigmoid is in effect an approximation
to the threshold function above, but
has a gradient that we can use for learning

- Sigmoid function is defined as

$$\sigma[f] = \left[\frac{2}{1 + \exp[-f]} \right] - 1$$

- Derivative of sigmoid

$$\frac{\partial \sigma}{\partial f} [f] = .5 * (\sigma[f] + 1) * (1 - \sigma[f])$$

Squared Error for Perceptron with Sigmoidal Output

- Squared error = $E[\underline{w}] = \sum_i [\sigma(f[\underline{x}(i)]) - y(i)]^2$

where $\underline{x}(i)$ is the i th input vector in the training data, $i=1, \dots, N$
 $y(i)$ is the i th target value (-1 or 1)

$f[\underline{x}(i)] = \sum w_j x_j$ is the weighted sum of inputs
 $\sigma(f[\underline{x}(i)])$ is the sigmoid of the weighted sum

- Note that everything is fixed (once we have the training data) except for the weights \underline{w}
- So we want to minimize $E[\underline{w}]$ as a function of \underline{w}

Gradient Descent Learning of Weights

Gradient Descent Rule:

$$\underline{\mathbf{W}}_{\text{new}} = \underline{\mathbf{W}}_{\text{old}} - \eta \Delta (\mathbf{E}[\underline{\mathbf{w}}])$$

where

$\Delta (\mathbf{E}[\underline{\mathbf{w}}])$ is the gradient of the error function E wrt weights, and η is the learning rate (small, positive)

Notes:

1. This moves us downhill in direction $\Delta (\mathbf{E}[\underline{\mathbf{w}}])$ (steepest downhill)
2. How far we go is determined by the value of η

Gradient Descent Update Equation

- From basic calculus, for perceptron with sigmoid, and squared error objective function, gradient for a single input $\underline{x}(i)$ is

$$\Delta (E[\underline{w}]) = - (y(i) - \sigma[f(i)]) \partial\sigma[f(i)] x_j(i)$$

- Gradient descent weight update rule:

$$w_j = w_j + \eta (y(i) - \sigma[f(i)]) \partial\sigma[f(i)] x_j(i)$$

- can rewrite as:

$$w_j = w_j + \eta * \text{error} * c * x_j(i)$$

Pseudo-code for Perceptron Training

```
Initialize each  $w_j$  (e.g., randomly)
```

```
While (termination condition not satisfied)
```

```
  for  $i = 1 : N$  % loop over data points (an iteration)
```

```
    for  $j = 1 : d$  % loop over weights
```

```
       $\text{deltaw}_j = \eta ( y(i) - \sigma[f(i)] ) \partial\sigma[f(i)] x_j(i)$ 
```

```
       $w_j = w_j + \text{deltaw}_j$ 
```

```
    end
```

```
  calculate termination condition
```

```
end
```

- Inputs: N features, N targets (class labels), learning rate η
- Outputs: a set of learned weights

Comments on Perceptron Learning

- Iteration = one pass through all of the data
- Algorithm presented = incremental gradient descent
 - Weights are updated after visiting each input example
 - Alternatives
 - Batch: update weights after each iteration (typically slower)
 - Stochastic: randomly select examples and then do weight updates
- A similar iterative algorithm learns weights for thresholded output (step function) perceptrons
- Rate of convergence
 - $E[\underline{w}]$ is convex as a function of \underline{w} , so no local minima
 - So convergence is guaranteed as long as learning rate is small enough
 - But if we make it too small, learning will be *very* slow
 - But if learning rate is too large, we move further, but can overshoot the solution and oscillate, and not converge at all

Support Vector Machines (SVM): “Modern perceptrons” (section 18.9, R&N)

- A modern linear separator classifier
 - Essentially, a perceptron with a few extra wrinkles
- Constructs a **“maximum margin separator”**
 - A linear decision boundary with the largest possible distance from the decision boundary to the example points it separates
 - “Margin” = Distance from decision boundary to closest example
 - The “maximum margin” helps SVMs to generalize well
- Can embed the data in a non-linear higher dimension space
 - Constructs a linear separating hyperplane in that space
 - **This can be a non-linear boundary in the original space**
 - Algorithmic advantages and simplicity of linear classifiers
 - Representational advantages of non-linear decision boundaries
- **Currently most popular “off-the shelf” supervised classifier.**

Constructs a “maximum margin separator”

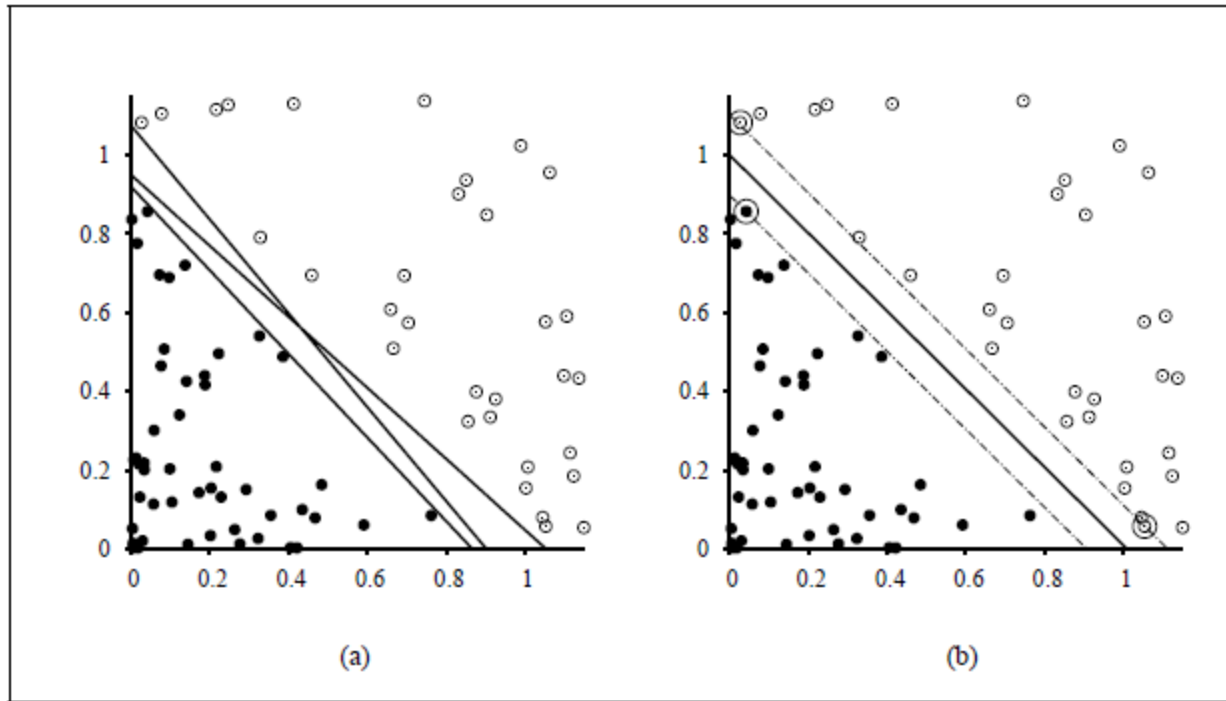
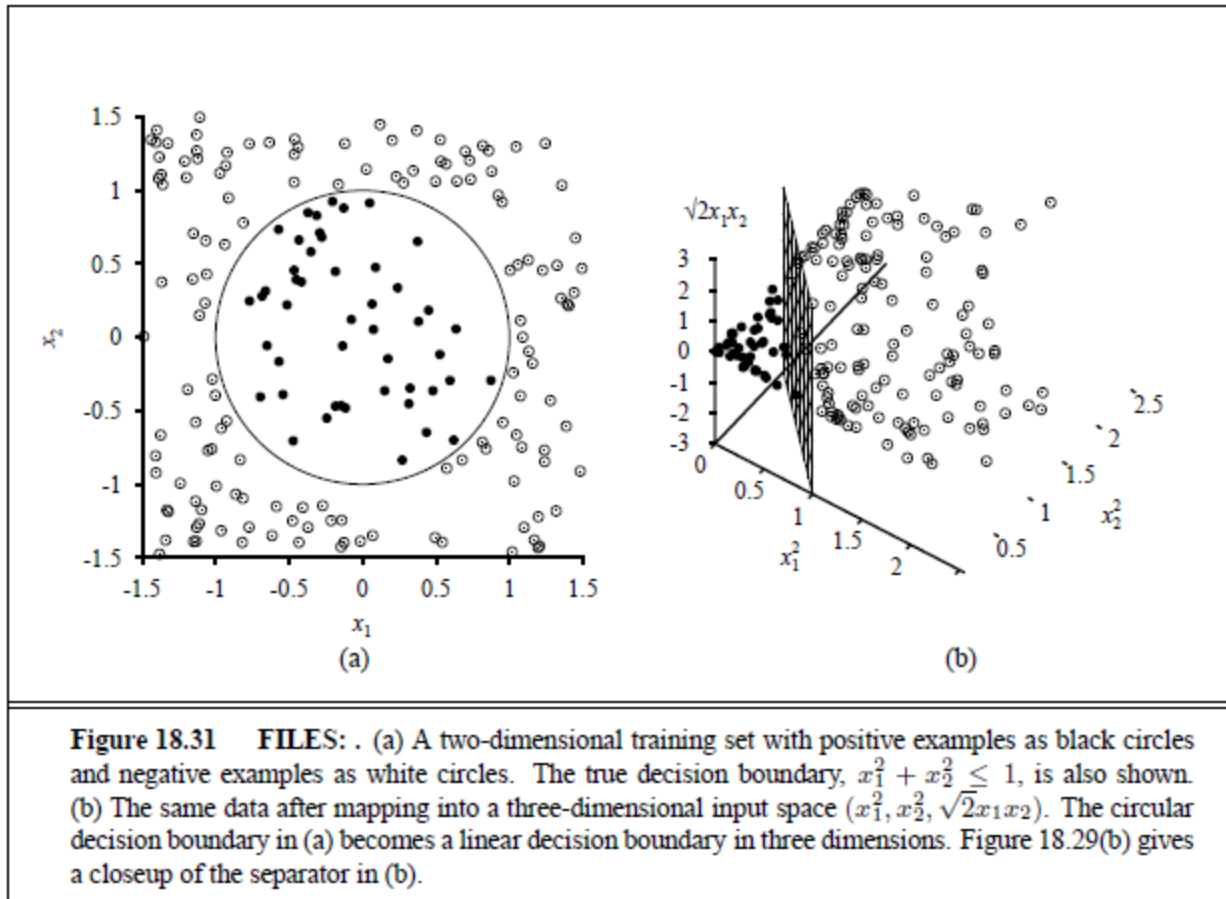

Figure 18.30 FILES: . Support vector machine classification: (a) Two classes of points (black and white circles) and three candidate linear separators. (b) The maximum margin separator (heavy line), is at the midpoint of the **margin** (area between dashed lines). The **support vectors** (points with large circles) are the examples closest to the separator.

Can embed the data in a non-linear higher dimension space



Multi-Layer Perceptrons (Artificial Neural Networks)

(sections 18.7.3-18.7.4 in textbook)

- What if we took K perceptrons and trained them in parallel and then took a weighted sum of their sigmoidal outputs?
 - This is a multi-layer neural network with a single “hidden” layer (the outputs of the first set of perceptrons)
 - If we train them jointly in parallel, then intuitively different perceptrons could learn different parts of the solution
 - They define different local decision boundaries in the input space
- What if we hooked them up into a general Directed Acyclic Graph?
 - Can create simple “neural circuits” (but no feedback; not fully general)
 - Often called neural networks with hidden units
- How would we train such a model?
 - Backpropagation algorithm = clever way to do gradient descent
 - Bad news: many local minima and many parameters
 - training is hard and slow
 - Good news: can learn general non-linear decision boundaries
 - Generated much excitement in AI in the late 1980’s and 1990’s
 - New current excitement with very large “deep learning” networks

Multi-Layer Perceptrons (Artificial Neural Networks)

(sections 18.7.3-18.7.4 in textbook)

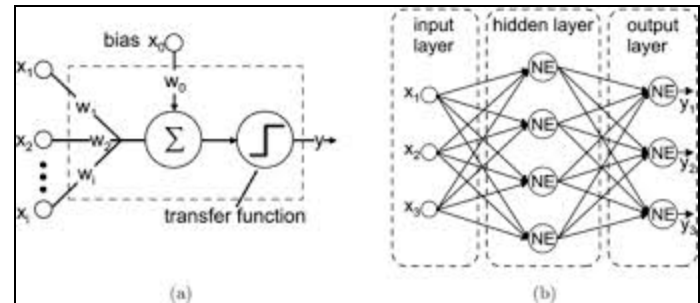
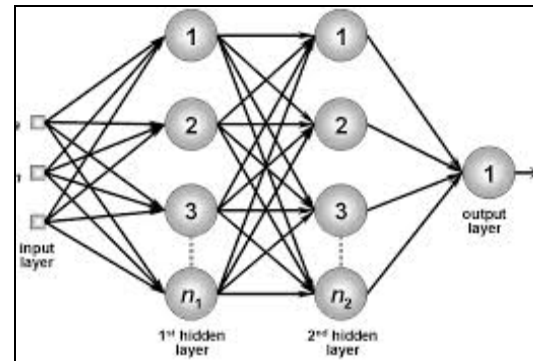
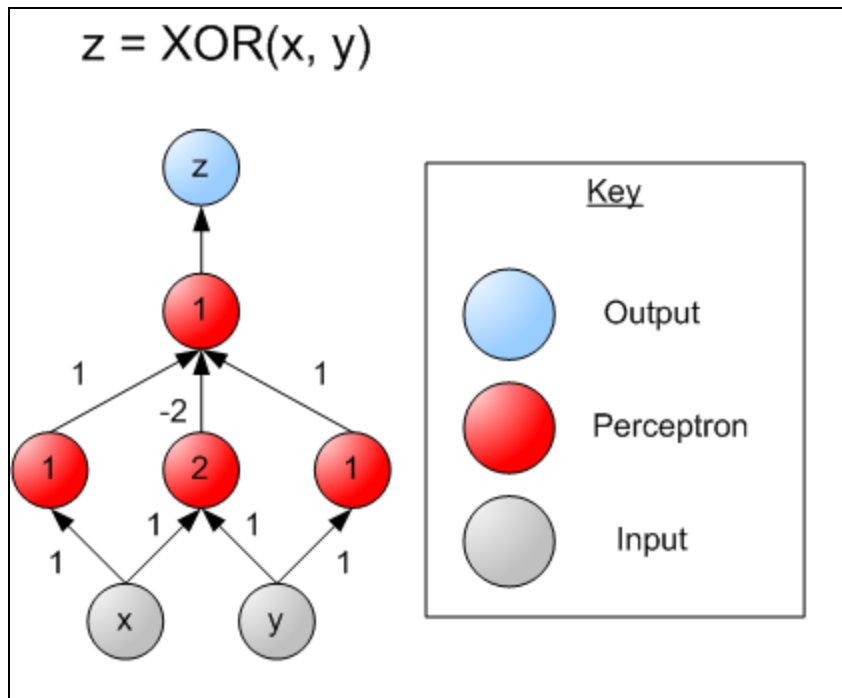

Cutting Edge of Machine Learning: Deep Learning in Neural Networks

Thanks to
Pierre Baldi

Thanks to
Xiaohui Xie

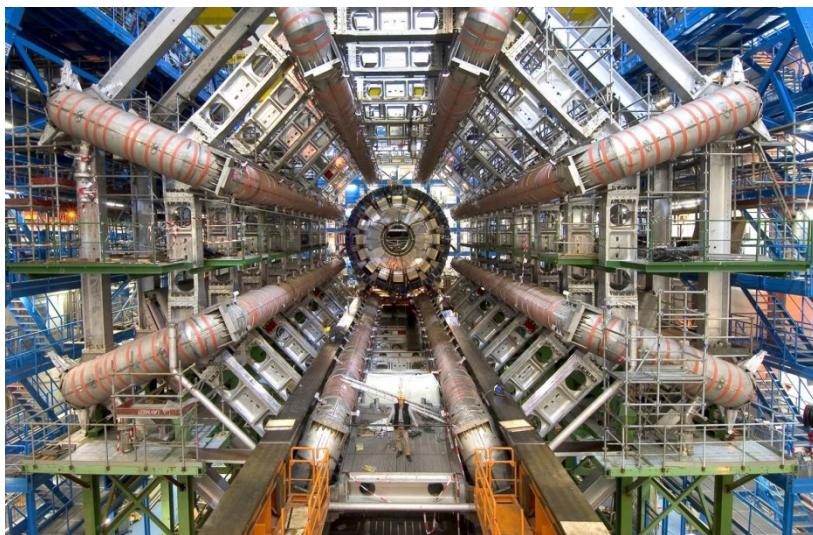

F

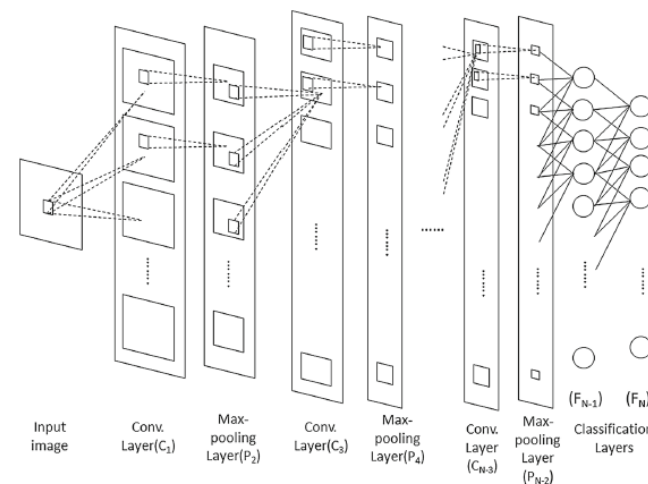
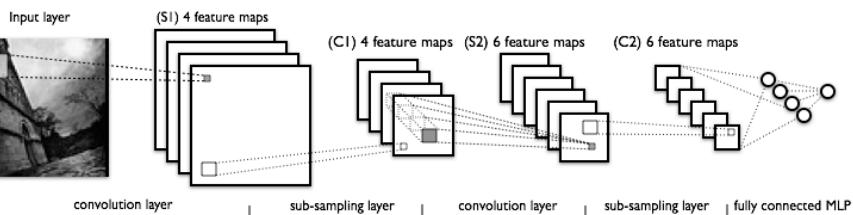

Fig. 2 The overall architecture of the DCNN used by us, which includes an input layer, multiple alternating convolution and max-pooling layers, and two fully connected classification layers. N denotes the total number of layers in the network



PRO:

- * Good results on hard problems
- * Combine feature extraction with classification directly from image

CON:

- * Can be difficult to train; gradient descent does not work well
- * Can be slow to train; but fast computers and modern techniques help

Naïve Bayes Model

(section 20.2.2 R&N 3rd ed.)

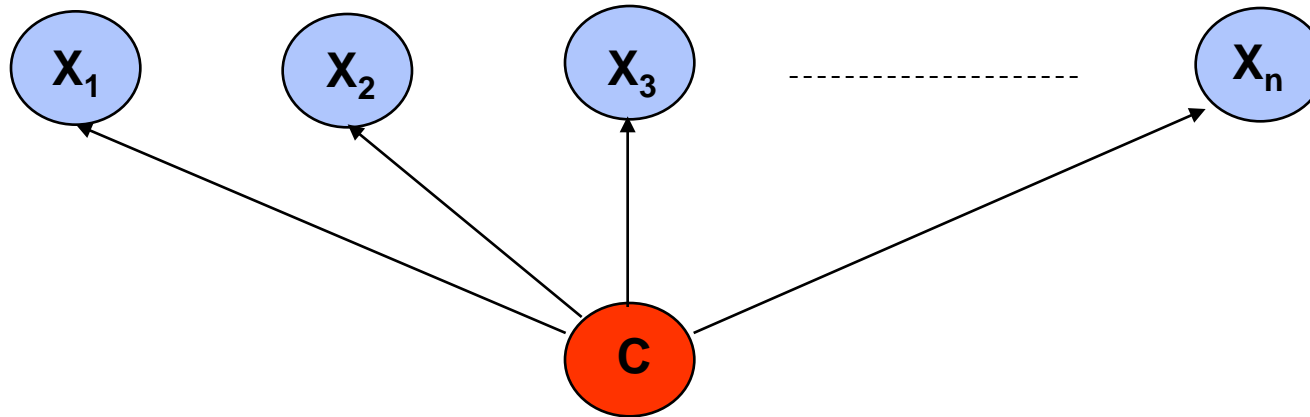

Basic Idea: We want to estimate $P(C | X_1, \dots, X_n)$, but it's hard to think about computing the probability of a class from input attributes of an example.

Solution: Use Bayes' Rule to turn $P(C | X_1, \dots, X_n)$ into a proportionally equivalent expression that involves only $P(C)$ and $P(X_1, \dots, X_n | C)$. Then assume that feature values are conditionally independent given class, which allows us to turn $P(X_1, \dots, X_n | C)$ into $\prod_i P(X_i | C)$.

We estimate $P(C)$ easily from the frequency with which each class appears within our training data, and we estimate $P(X_i | C)$ easily from the frequency with which each X_i appears in each class C within our training data.

Naïve Bayes Model

(section 20.2.2 R&N 3rd ed.)

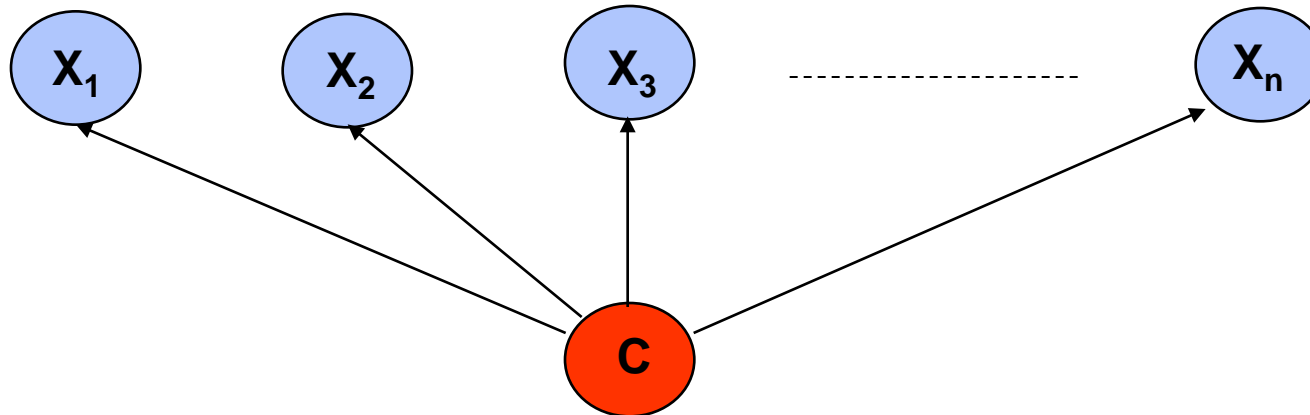

Bayes Rule: $P(C | X_1, \dots, X_n)$ is proportional to $P(C) \prod_i P(X_i | C)$
[note: denominator $P(X_1, \dots, X_n)$ is constant for all classes, may be ignored.]

Features X_i are conditionally independent given the class variable C

- choose the class value c_i with the highest $P(c_i | x_1, \dots, x_n)$
- simple to implement, often works very well
- e.g., spam email classification: X 's = counts of words in emails

Conditional probabilities $P(X_i | C)$ can easily be estimated from labeled data

- Problem: Need to avoid zeroes, e.g., from limited training data
- Solutions: Pseudo-counts, beta[a,b] distribution, etc.

Naïve Bayes Model (2)

$$P(C | X_1, \dots, X_n) = \alpha P(C) \prod_i P(X_i | C)$$

Probabilities $P(C)$ and $P(X_i | C)$ can easily be estimated from labeled data

$$P(C = c_j) \approx \#(\text{Examples with class label } C = c_j) / \#(\text{Examples})$$

$$P(X_i = x_{ik} | C = c_j) \\ \approx \#(\text{Examples with attribute value } X_i = x_{ik} \text{ and class label } C = c_j) \\ / \#(\text{Examples with class label } C = c_j)$$

Usually easiest to work with logs

$$\log [P(C | X_1, \dots, X_n)] \\ = \log \alpha + \log P(C) + \sum \log P(X_i | C)$$

DANGER: What if ZERO examples with value $X_i = x_{ik}$ and class label $C = c_j$?
An unseen example with value $X_i = x_{ik}$ will NEVER predict class label $C = c_j$!

Practical solutions: Pseudocounts, e.g., add 1 to every $\#()$, etc.
Theoretical solutions: Bayesian inference, beta distribution, etc.

Classifier Bias — Decision Tree or Linear Perceptron?

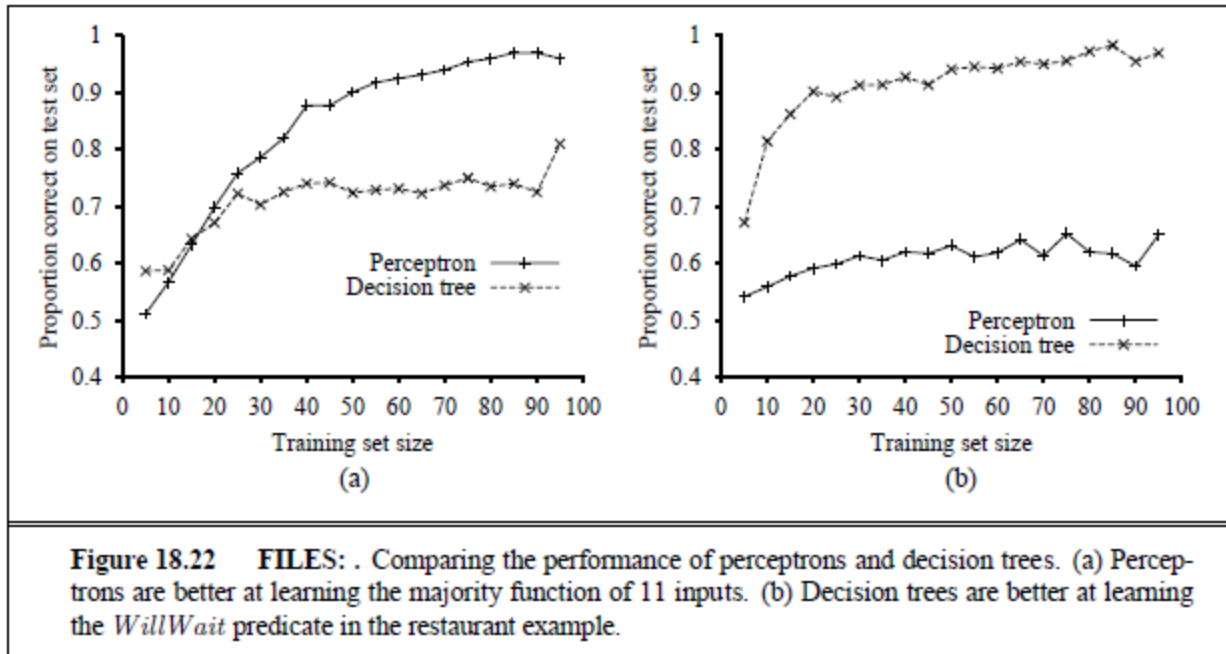

Classifier Bias — Decision Tree or Linear Perceptron?

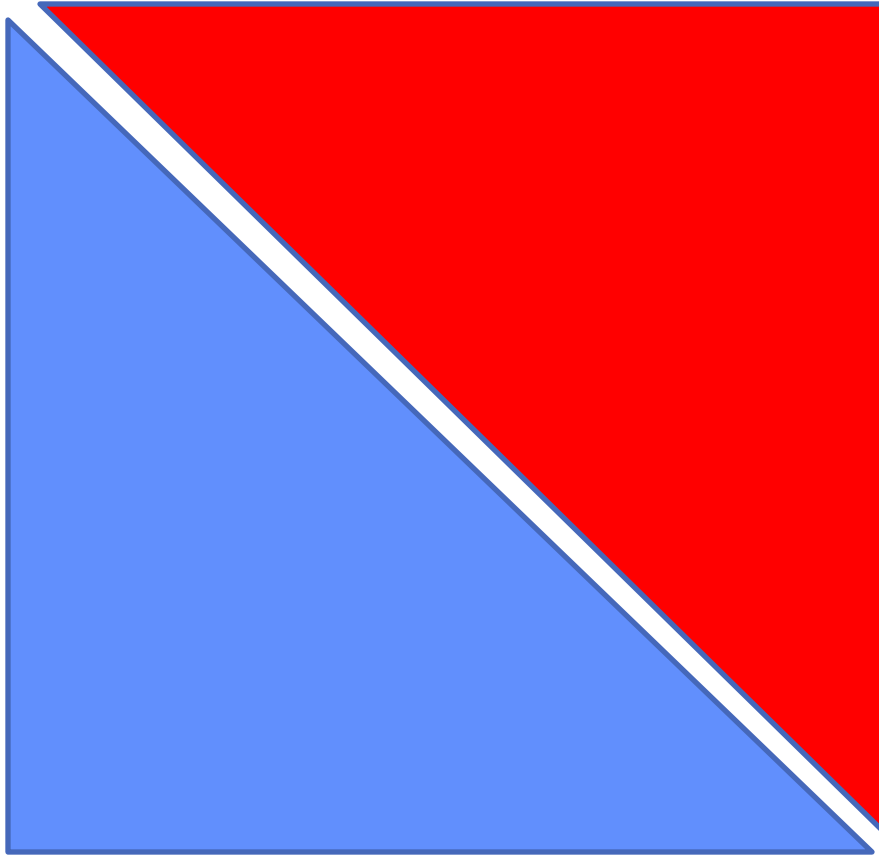

Classifier Bias — Decision Tree or Linear Perceptron?

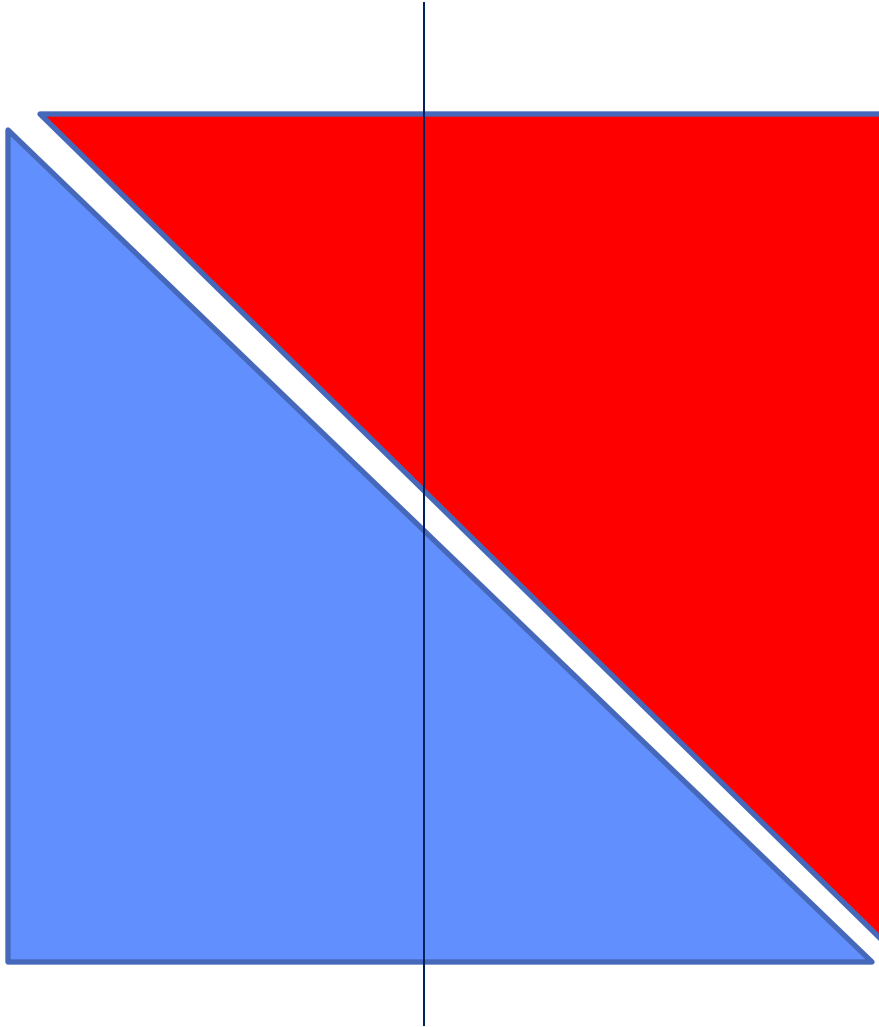

Classifier Bias — Decision Tree or Linear Perceptron?

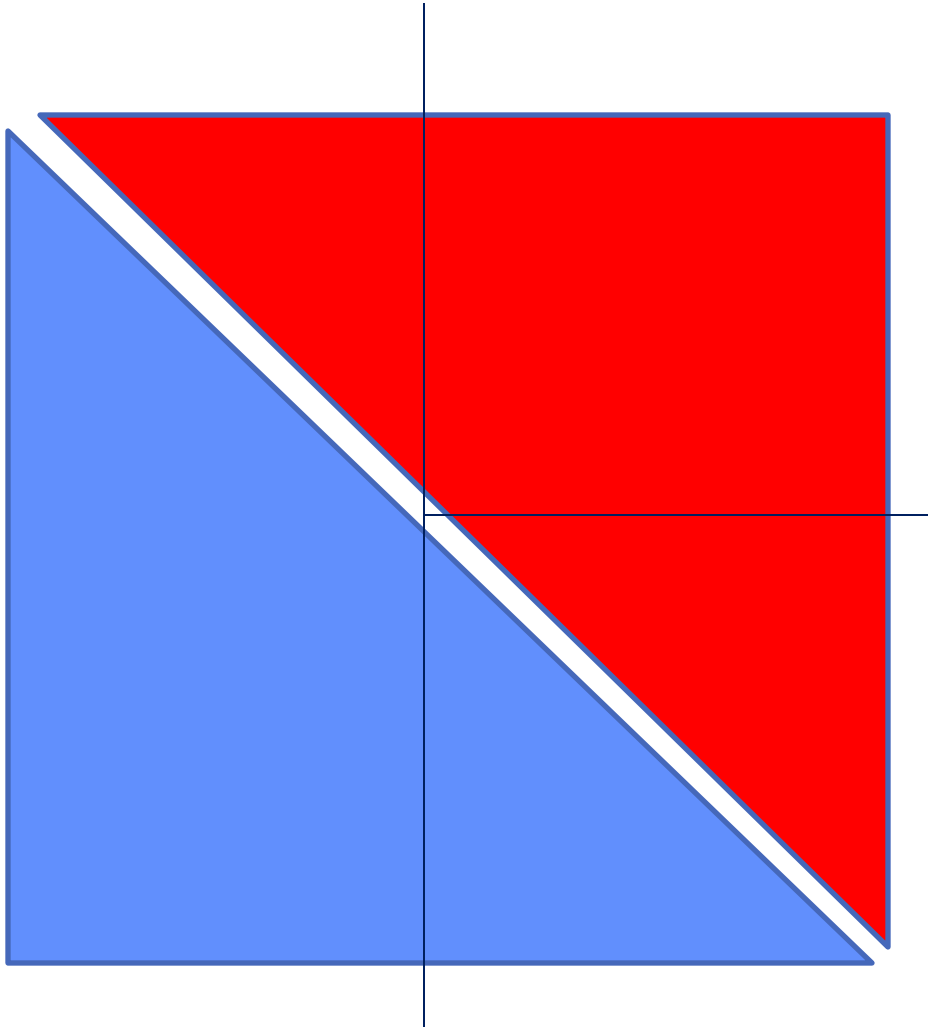

Classifier Bias — Decision Tree or Linear Perceptron?

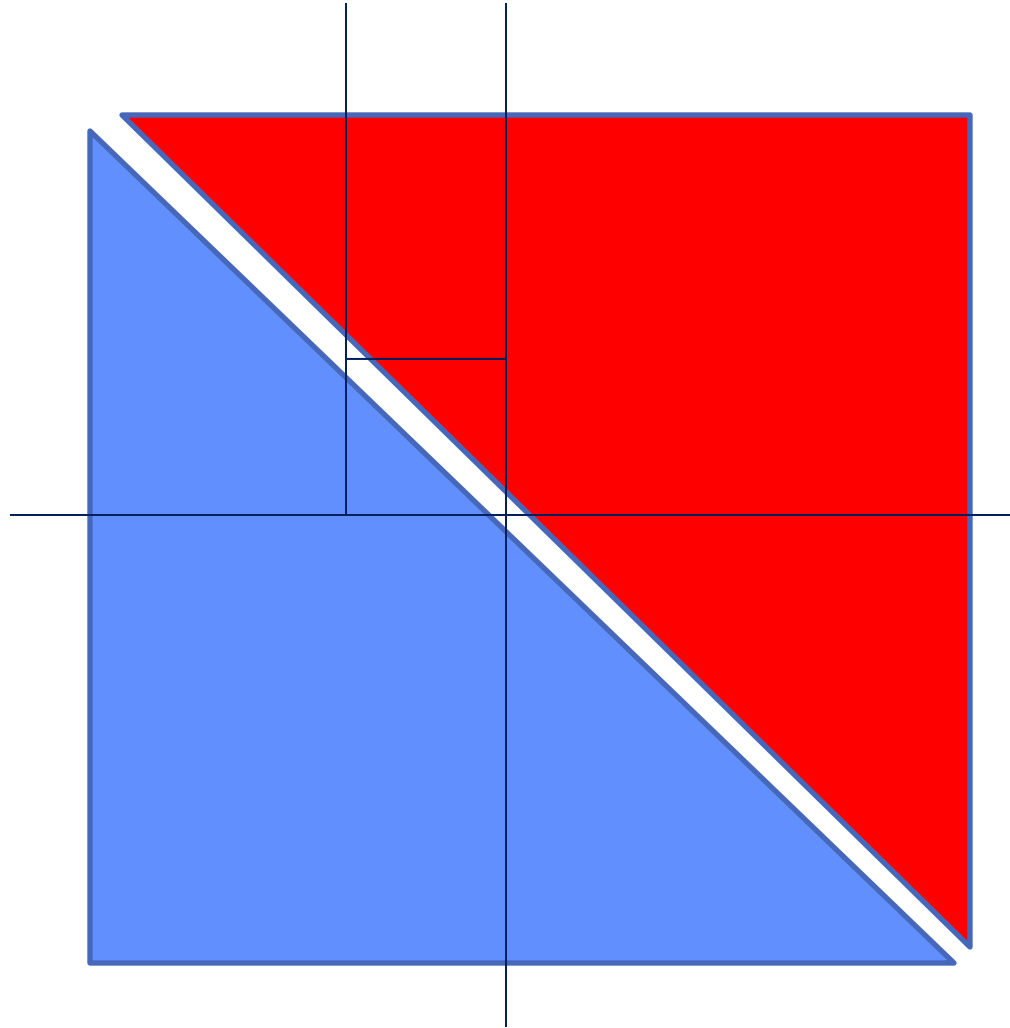

Classifier Bias — Decision Tree or Linear Perceptron?

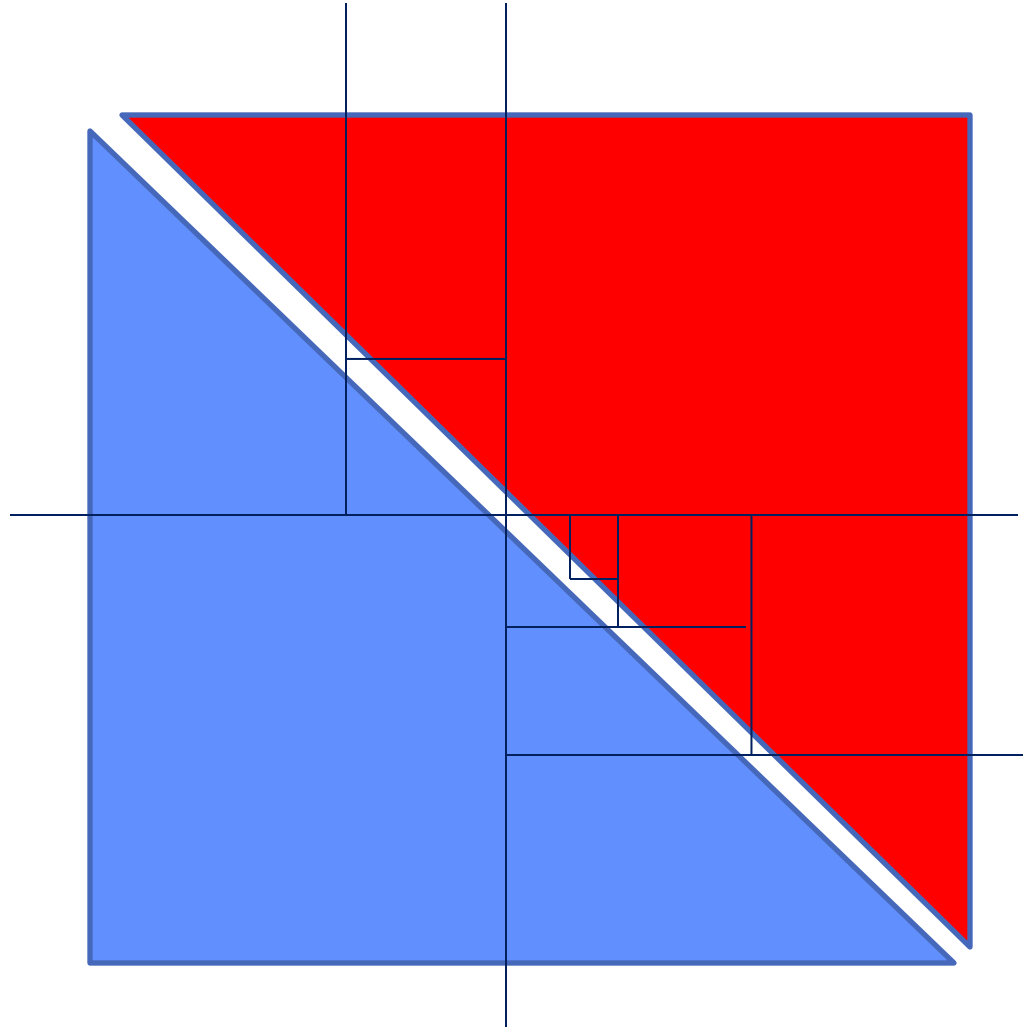

Classifier Bias — Decision Tree or Linear Perceptron?

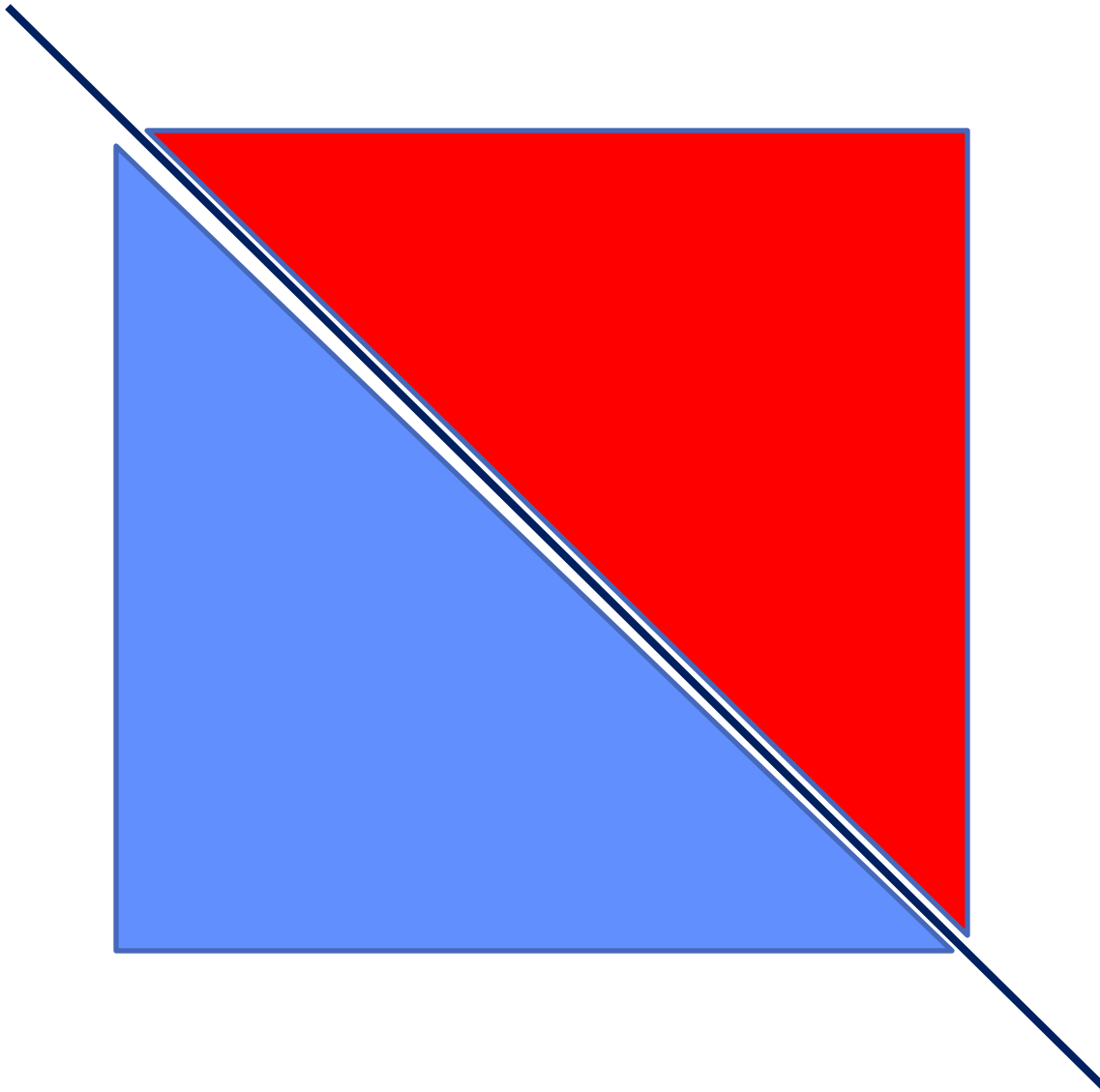

Classifier Bias — Decision Tree or Linear Perceptron?

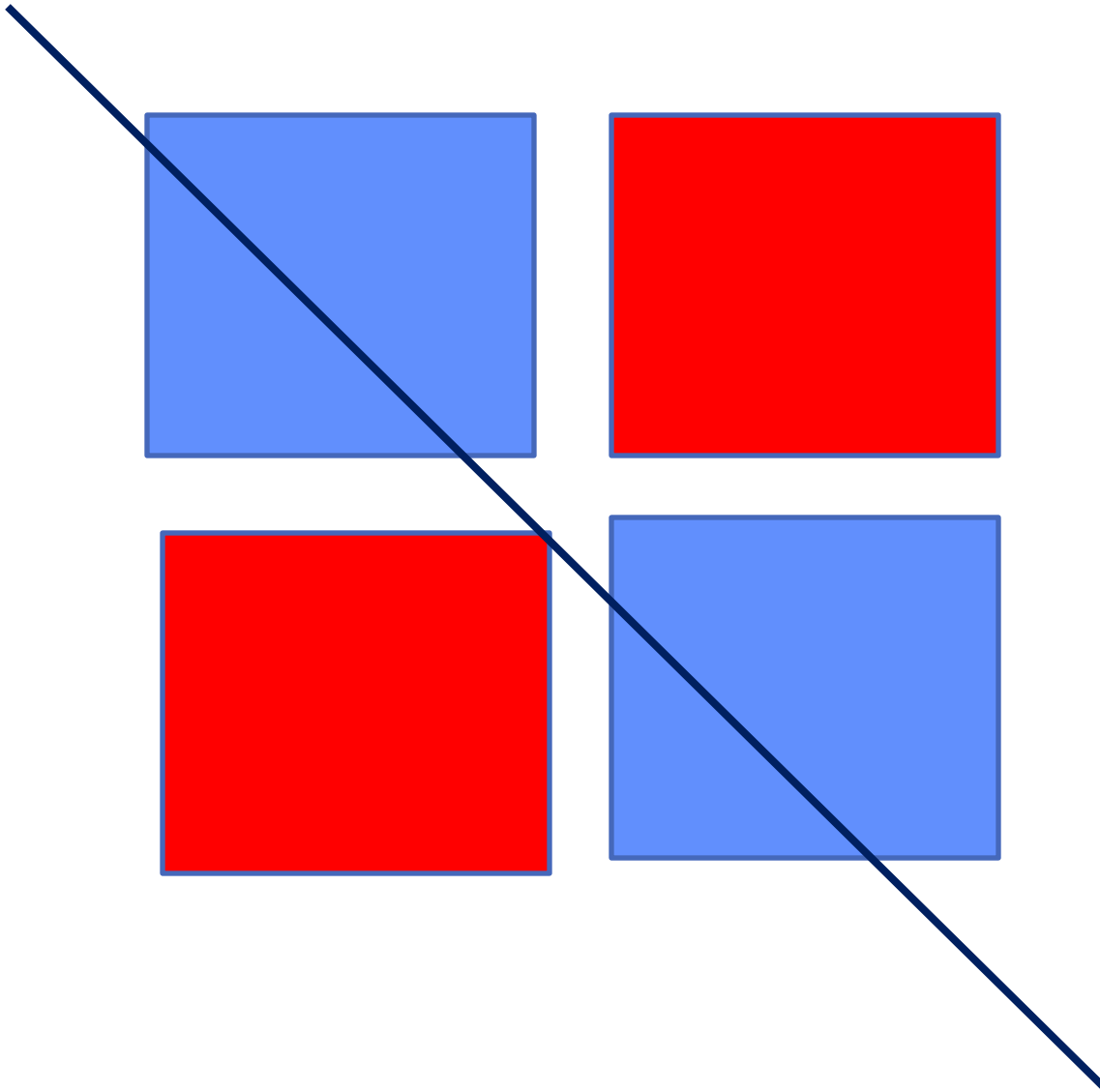

Classifier Bias — Decision Tree or Linear Perceptron?

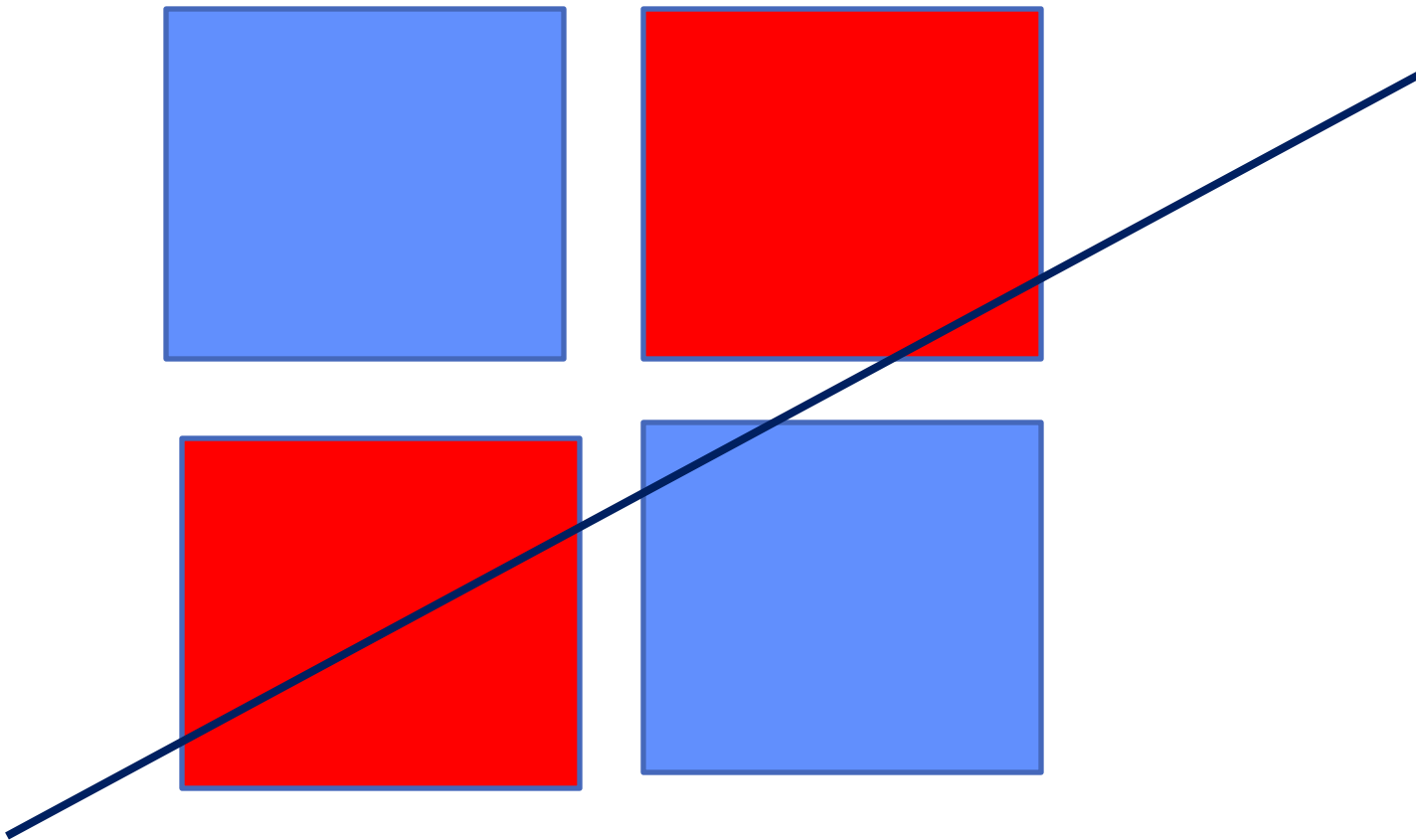

Classifier Bias — Decision Tree or Linear Perceptron?

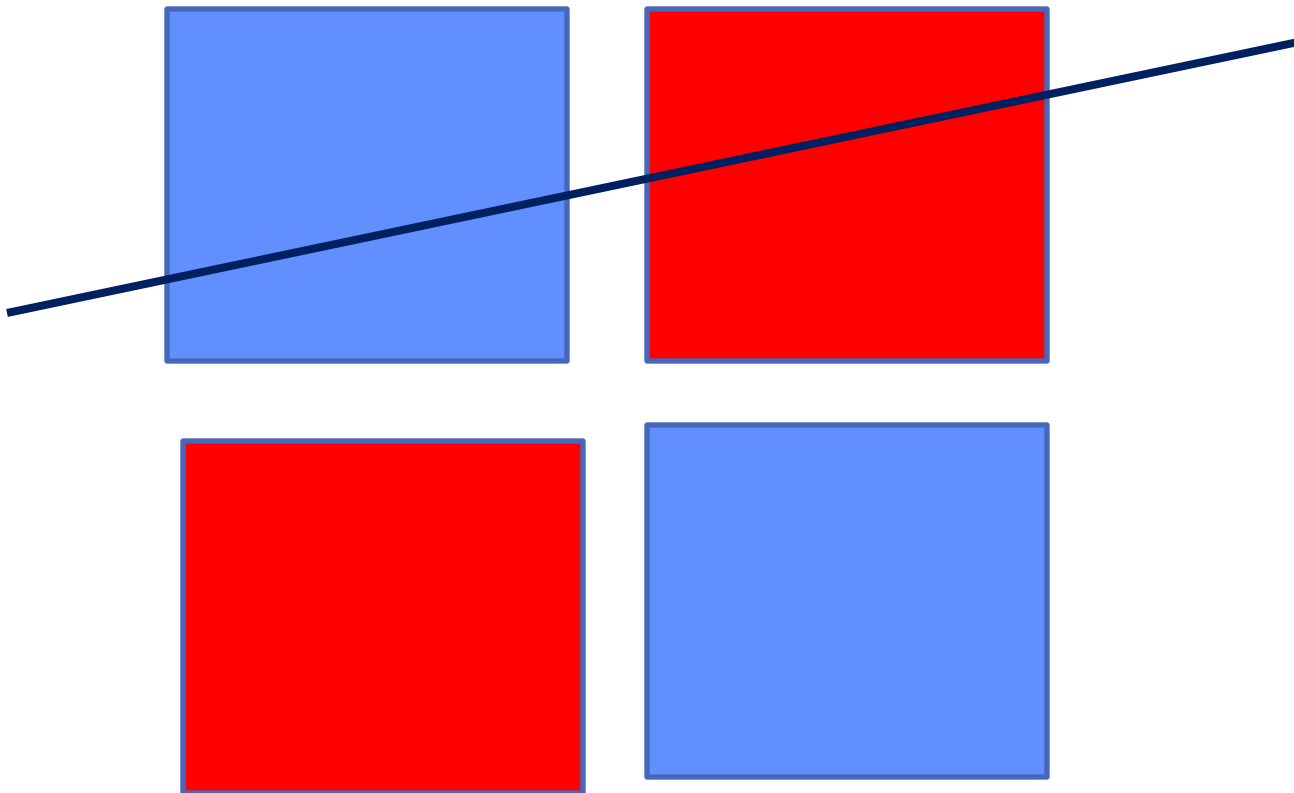

Classifier Bias — Decision Tree or Linear Perceptron?

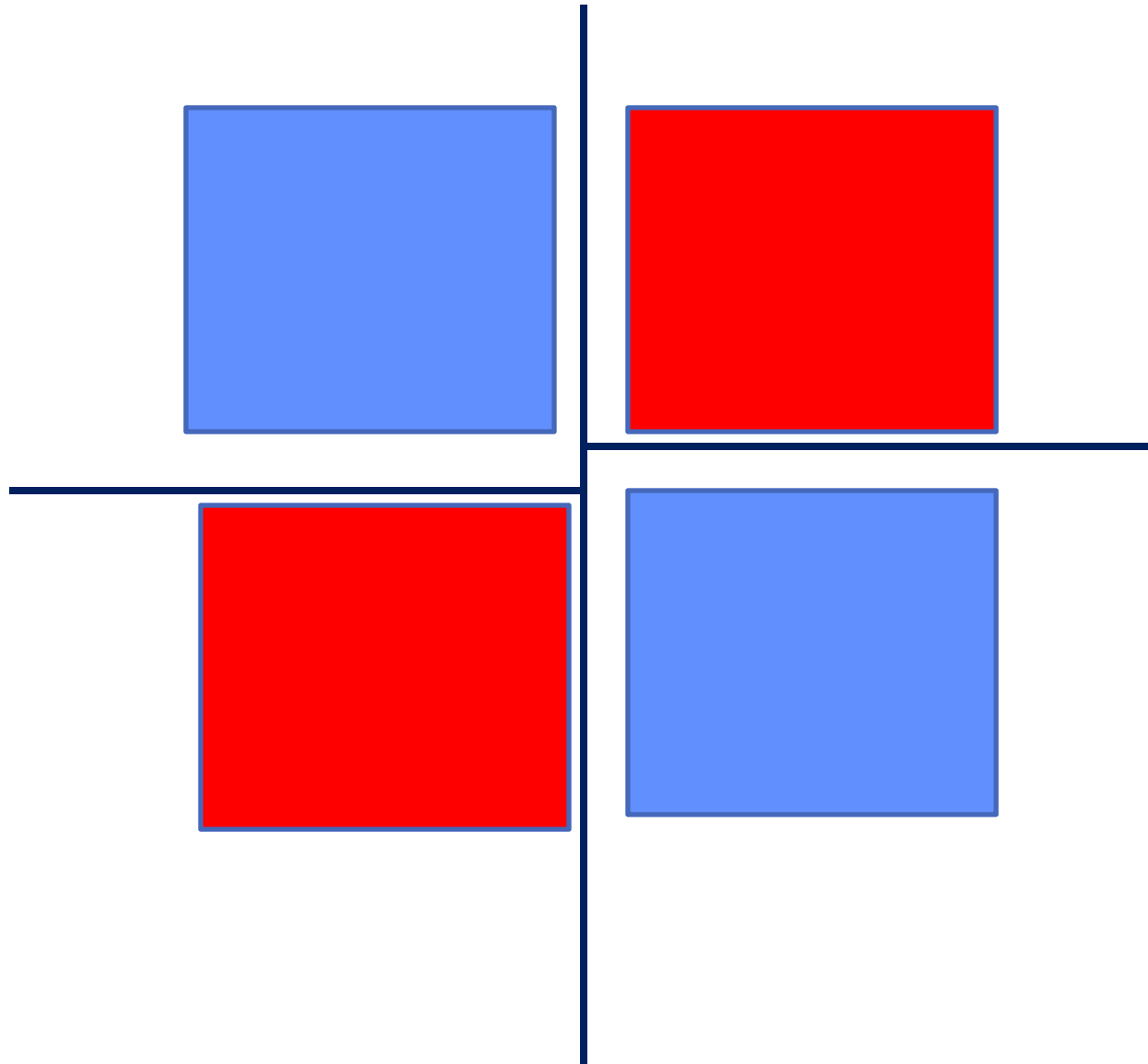

Summary

- Learning
 - Given a training data set, a class of models, and an error function, this is essentially a search or optimization problem
- Different approaches to learning
 - Divide-and-conquer: decision trees
 - Global decision boundary learning: perceptrons
 - Constructing classifiers incrementally: boosting
- Learning to recognize faces
 - Viola-Jones algorithm: state-of-the-art face detector, entirely learned from data, using boosting+decision-stumps